



Est. USA 1981

www.AKCP.com

SP2+ Introduction Manual



Copyright © 2022, AKCP



Table of Contents (please use the Ctrl F “search” for locating the exact sections & pages)

- Introduction**
- Port assignment information for SP2+ units & ports locked info**
- LED information for SP2+ units**
- Reset button functions for SP2+ units**
- Setting up the unit’s IP address & troubleshooting - Dual Power Input Options**
- SP2+ Web UI Walkthrough**
- Menu navigation**
- Monitoring Summary page**
- Graph feature**
- Expansion units**
- Managing Desktops and rack Maps (& Map Feature on F7/H7)**
- Important Notes on custom desktops**
- Managing Desktops**
- Navigation**
- Folders**
- Desktops**
- Adding items to your custom desktop**
- Desktop Auto Scroll feature**
- Managing Rack Maps**
- Access Control Users and Groups**
- Notifications and Events, Sensors menu, Settings menu**
- System page**
- General**
- Language management**
- Date/Time**
- Network**
- Modem**
- VPN**
- Set up VPN connection to APS (AKCPro Server)**
- SMTP (setup for gmail & office365)**



SNMP

Server Integration

Services

SSL Certificate

Modbus

Password Checking and security

Password Security options

Maintenance (create support files & backups etc.)

Heartbeat Messages

License Management

About

Sensor's page.....

General options for all sensors

Virtual sensors

Example sensor configuration

Temperature/Humidity Sensor

Relay Sensor

Firmware upgrade through the Web UI.....

Network ports used by SP+ units.....

FCC Statement.....

Introduction

In this manual, we'll cover the main features and basic configuration of the SP2+ and the setup of notifications and the explanation of events will be in the "Notifications" manual. Please also see our Knowledge Base page here: <https://www.akcp.com/knowledge-base/sensorprobe-plus-series-knowledge-base/>

What is the SP2+?

The SP2+ is a high speed, accurate, intelligent monitoring device, featuring a completely embedded host and operating system. The SP2+ is a complete redesign of the world's best-selling environmental monitoring platform, 3 years in the making with all new hardware and software. We've combined the low cost and simplicity of use of the SP2, along with many advanced features of our securityProbe platform.

The SP+ units support a maximum of 150 sensors (data points) per unit. This unit supports up to 4 (physical) sensors (with the 4PUN unlock code explained below).

SP2 + Features:

- IP based, including SNMPv3, HTTPS, VPN
- Send encrypted SNMP Trap and Email Notifications
- Supports 4 Intelligent Sensors or up to 20 Dry Contacts (with unlock codes)
- Optional cellular modem with external antenna
- Notification Wizards
- Front and Rear Thermal Mapping for any server cabinet
- Optional Expansion Module connectivity
- Virtual Sensors
- AKCP Swing Handle Lock support

Please check all the specifications & features on our SP2+ datasheet:

<https://www.akcp.com/support-center/media-pack/>

Important notes:

A) Some of the pictures shown in this manual might not represent the actual Web UI of the unit; this is because we are constantly working on improving the firmware. Please provide us with feedback if you have any issues configuring your unit.

B) **All SP+ H7 type units with firmware version 1.0.5824 are now shipped with DHCP enabled by default.** See below beginning on page #10 for more details. If you do not use DHCP on your network, the unit will revert to the fixed IP address of 192.168.0.100. Please see the section in this manual on how to setup a new IP address on the unit. The SP+ F4 & F7 type units will not be affected.

C) AKCP also always highly recommends using a **dedicated 3rd party UPS on the units**. Any damage caused by unstable power or power outages *will void the warranty* on our units.

What's the difference between the SP2+ and SPX+?

The SP2+ has 4 sensor ports for connecting any compatible AKCP sensor. With the Expansion option it has 3 sensor ports and 1 expansion port.

The SPX+ also supports expansion modules and has modular design allowing you to choose your own configuration.

We have several standard configurations, but with the AKCP Configuration Tool you are able to custom design a unit to your own specifications. See below for available modules to choose from.

What's the difference between F4 (older) F7 & H7 (newer) processor versions?

The F4 SP+ & the F7 & H7 SP+ processors - or as we will refer to them as platforms are different. The new F7 & H7 processor or platforms support more memory on the SP+ (SP2+ and SPX+) units, thus more features. Future firmware development will concentrate on the H7 units. The F4 & F7 units will not support new features.

The most notable difference between the platforms is the supported number of sensors when the VPN feature is enabled: the total sensor count is reduced to 36 on F4 units, but it is still 150 on F7 & H7 units.

When upgrading the firmware, there are three separate .bin files included in the firmware update packages. One for the F4 units, one for the F7 units and one for the H7 units.

If you try to upgrade your unit with the wrong .bin file, the firmware upgrade will fail. So please make sure you use the correct file for your unit type following the firmware upgrade instructions in the text file that is included in the compressed firmware package.

Also, **very important to note** that any backup configuration created on the F4 platform cannot be uploaded to the F7 platform unit and vice versa. This also applies to the H7 units. Backup configurations created on the F7 units are compatible with the H7 units (only SP2+ to SP2+).

F7 Units Specifications:

AKCP STM32F7 MCU
32-bit ARM micro-processor
512KB of Ram
32MB of non-volatile flash

H7 Units Specifications:

AKCP STM32H7 MCU
32-bit ARM micro-processor
1MB of RAM
64MB of non-volatile flash

CPU speed: 216 MHz (F7) to 460 MHz (H7) The H7 is significantly faster than the F7 in real usage. In the SP+ units web UI you will be able to view which platform the unit is using.

This can be checked in the Settings >> General page >> System Description:



And in the Settings >> About page >> System Description:

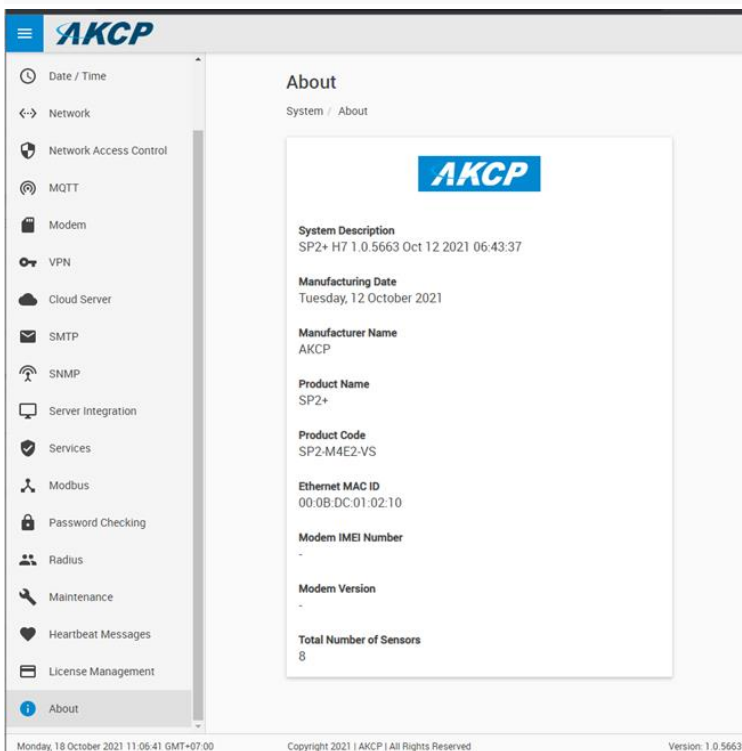
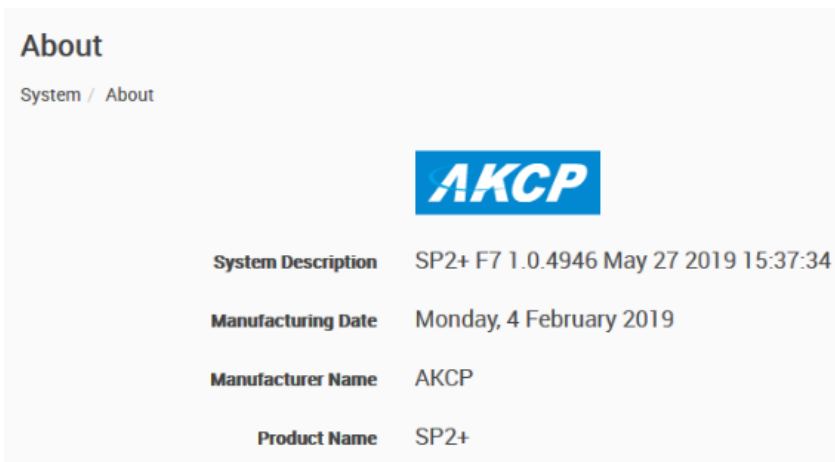

Port assignment information for SP2+ units



Port numbering starts from the power connector on the unit: the closest port to the power connector is Port 1 and closest to the Ethernet interface is Port 4.

You may connect AKCP intelligent sensors to any available ports.

Important notes:

- The power adapters that are used on sensorProbe+ units **shipped after August 2017** are now **5 Volts**. Please verify the voltage of your sensorProbe+ before ordering replacement power supplies.
- If you're using analog pins on the sensor ports (with manually on-lined DCV sensors, and pin 7 of the RJ45 connector) make sure that the **voltage doesn't exceed 3 Volts**. Otherwise you can damage the unit!

Very Important Update – ALL SP2+ units (not including the SP2+E) ordered **FROM** December 1st 2021 will be shipped with the first two RJ-45 sensors ports unlocked. The remaining two sensors ports will be **LOCKED** and unusable unless the 4PUN license is, or was purchased for the SP2+.

New features on all F7 & H7 SP+ units for no extra license fees include:

- 5 free virtual sensors.
- HTTPS and encrypted secure E-mail support.
- Internal buzzer for audible alerts.
- SNMPV3 included now as standard
- HTML5 user interface, MQTT/MQTTS, IPV6 option. (MQTTS only supported on H7 units)
- Support for all NIST2 and NIST3 temp sensors. (supported on F7)
- The 4PUN is field upgradable with the unlock code.

If your SP2+ unit displays this regarding the RJ-45 sensors ports in the web UI below, then your units additional two sensors ports are not unlocked and not usable. Please contact our sales team if you required these to be unlocked and provide your units MAC ID.

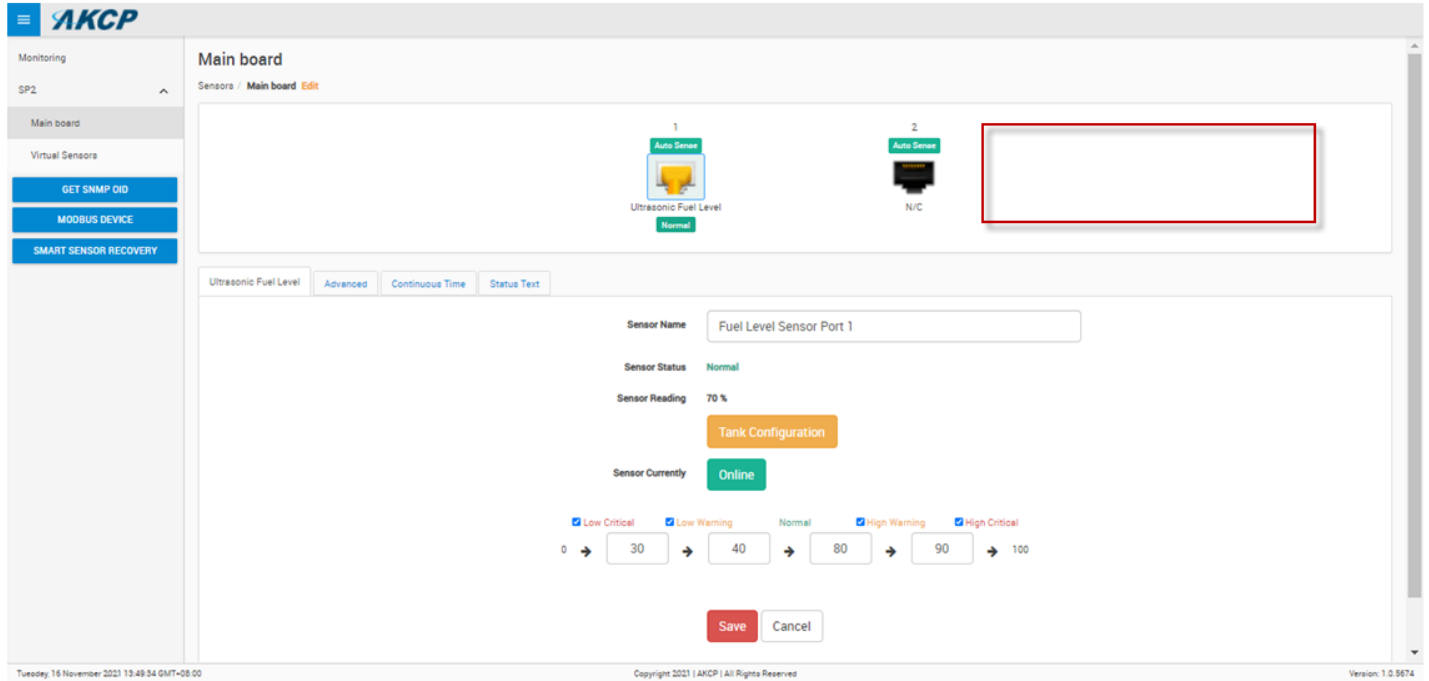

LED information for SP2+ units



Power/Ethernet Link - Sensor 1 - Sensor 2 - Sensor 3 - Sensor 4

The **Power/Ethernet LED** will become red if there's no network connection, and blinking green (according to LAN activity) when the connection is normal.

For **Sensor LEDs** (green):

Off = offline

On = online and normal

Slow blinking = Warning status

Fast blinking = Critical and Error status

The internal **Buzzer** can provide audible notifications for sensor statuses. Please check our separate SP+ Buzzer manual for using this feature.

Reset button functions for SP2+ units

There are specific commands you can send to the unit by holding the Reset button for a specified amount of time.

You'll have to use something sharp, such as a straightened paperclip to be able to press Reset.



Commands:

Time to hold	Action
< 3 sec	Speak/show IP and broadcast its info (display on LCD sensor too, if connected)
3..7 sec	Reboot (reset CPU)
7..12 sec	Web UI password reset
12..17 sec	Clear the sensor, notification and access DBs, logs Serial flash erase (DB erase without factory reset, the system configuration is kept)
17..25 sec	Reset to factory defaults (serial flash erase + config erase)
> 25 sec	No action (useful when the button was pressed by mistake)

Notes:

- When the Reset button is held for longer than 12 seconds (DB erase) and then released, the Sensor Port 1 and 2 LEDs will give a visual indication of the state of database erase (the reboot and password reset doesn't have visual indication).
- When the button is held longer than 17 seconds (factory reset) and then released, these sensor port LEDs will be blinking fast and alternate during the factory reset mode.

Setting up the unit's IP address & troubleshooting connection issues

Important Note: The unit's ship with the passwords **enabled**. The default log in for the web interface is Username: *admin* Password: *public*

IMPORTANT UPDATE – The changes below on how to connect to the SP+ (**H7 type only**) units has been implemented when upgrading or using firmware version v1.0.5824 or higher. This ***DOES NOT*** apply to, or affect any F7 or H7 SP+ units already in the field or previously shipped when upgrading to the v1.0.5824 firmware.

Note: *This will also not apply to the F4 type units (final firmware version supported is v1.0.5606).*

Please follow the directions in this SP+ setup video or the image for first connecting your unit:

<https://www.youtube.com/watch?v=OtrccRpm1cw>

Important Note: If you do not have a DHCP server, or do not use DHCP then the unit will only try DHCP for a few seconds, if there's no reply it will fall back to the default IP address of 192.168.0.100. Then you can use the direct cross over cable connection to your laptop or PC. Or simply connect the unit to your network switch and type in the default IP address above in your browser. **This also applies if you are using the SP+ F4 or F7 type units.**

Please note: The example in the video above & below shows our SP1+ unit. These steps will be the same for all SP+ (SP2+ & SPX+ H7) units shipped with firmware v1.0.5824.

sensorProbe+ Quick Start Guide

- 1) Plug in the device to a DHCP Enabled network with internet connection
- 2) Power on the device
- 3) Open your web browser (Google Chrome recommended) and go to <https://apscloud.akcp.com>
- 4) Sign in, or create your account. New users can create an AKCPro Server cloud account (free for up to 4 devices for 12 months).
- 5) In AKCPro Server add a new AKCP Cloud Device and enter the MAC ID of the sensorProbe+



- 6) The unit will appear in the server explorer window of AKCPro Server. To access its local web UI from here, open the device menu and select "Open local URL".

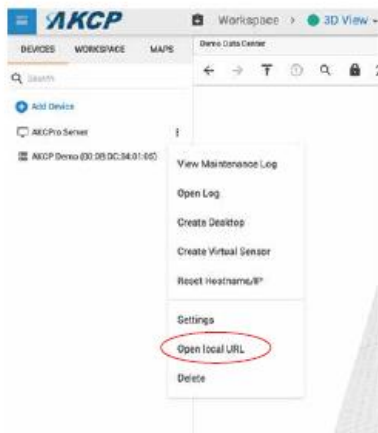

Additional Options for Connecting to your SP+ Units Web UI

Option #1. If using **DHCP** check your network router's DHCP assignments list.

How do I find the DHCP list on my router? (the following may be different depending on your router type)

Click the Status tab after logging into your router, then the Local Network sub-tab. Click the DHCP Client Table button under the DHCP Server section. This should bring up a list of clients that are currently connected to your network. You should see your SP+ unit in this list.

After identifying the IP address assigned, open your browser and type in the IP address.

Option #2. Use the IPSet utility (also applicable for the F4 & F7 type SP+ units).

- A. You can also try using our IPSET utility which you can download using the QR code or direct link here:



<http://www.akcp.in.th/downloads/Firmwares/lnuxIPSet6.0.0.zip>

- B. Start the IPSET utility. Press the “reset” button on the sensorProbe+ unit once. IPSET will detect the units IP address and allow you to open the units web interface.

Option #3. If you have our AKCP LCD display sensor.

Connect the LCD display to any sensor port on the unit. The IP address will be displayed in the LCD panel.

Option #4. If you are **NOT using a DHCP server** (after the unit has reverted back to the default IP address). Also applicable for the F4 & F7 type SP+ units.

Connect your SP+ unit directly to your network switch with a direct connect CAT5/6 cable and type in the default IP address of 192.168.0.100.

Re-assign your desired IP address in the Network settings as shown in the SP+ manuals.

VERY IMPORTANT NOTE: If you connect your SP+ (firmware versions beginning with 1.0.5824 or higher) unit directly to your laptop or PC using a cross over cable, DHCP will be temporarily disabled.

If you do not log into the unit’s web UI and set a fixed IP address, then if you re-connect the unit to your network switch (using a straight through cable), DHCP will be re-enabled again. This does **NOT** apply to the F4 or F7 type SP+ units or any H7 type SP+ units currently in the field prior to firmware v1.0.5824, or upgrading to the v1.0.5824.

Troubleshooting & Connection Problems

First please check our SP+ online Knowledge Base using this link to our website:

<https://www.akcp.com/knowledge-base/sensorprobe-plus-series-knowledge-base/>

- Make sure you can ping the units assigned or default IP address.
- Make sure your laptop, PC or network fixed IP is configured for the default network subnet as the unit (192.168.0.1 for example). And that the IPv4 is checked/enabled on your PC.
- Check the Ethernet link LED on the unit and the PC. Check the patch cable (direct connect = crossover. Connect to switch = straight through).
- Try temporarily disabling your Antivirus & Firewall.
- You can also try using our IPSET utility as described above.

IMPORTANT NOTE: If you have performed a complete factory reset on your SP+ H7 type (on firmware v1.0.5824 or higher) unit without choosing the option to retain the fixed IP address, then

your unit will default back to DHCP. Please refer to the steps above again to determine your units newly assigned IP address.

Note: In some cases, your computer might not be able to connect to this default IP address. In this situation you either need to:

- a) add this IP your computers routing table or
- b) add a secondary IP address to the LAN card to allow access to the unit.

See below how to setup these.

Ensure the following items are available to you before starting:

- RJ45 CAT5 crossover cable with RJ45 male connection
- A PC with Ethernet card or LAN socket, logged in with Administrator rights

1) Connect the unit via the Ethernet port of the unit to your computers LAN or Ethernet port with a CAT5 crossover cable.

2) Open a web browser and type the default IP address, hit enter.

You'll be presented by the **Summary** page.

Go to the **System/Network** page to change the network settings (see below in this manual).

Once you have assigned the new IP address use the "ping" command to test the unit's reply.

How to add a manual route to the computer's routing table?

Open an Administrator Command Prompt (CMD) window and type:

```
route add 192.168.0.100 10.1.1.20
```

Where 10.1.1.20 is the IP address of the Ethernet interface on the PC that the unit is plugged into with the crossover cable.

Note: If you do not receive an 'OK!' message then a parameter was wrong or missing. The route is not persistent (removed upon rebooting), but you can also delete it with the `route delete 192.168.0.100` command.

How to add a secondary IP address to the computer's LAN card?

You can do this via the GUI by opening the LAN connection's properties:

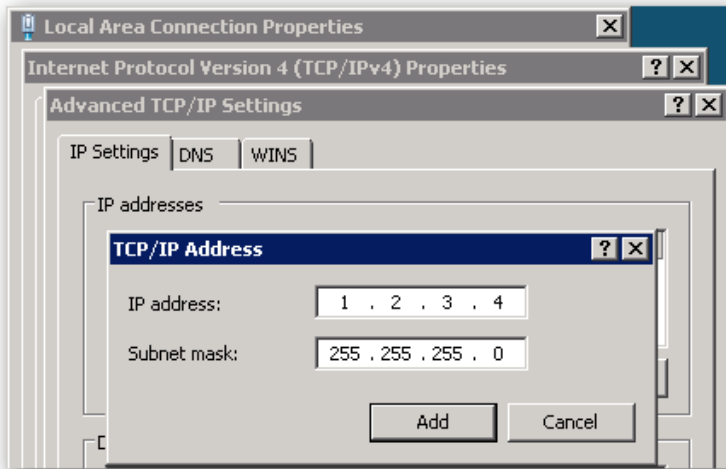

Or open an Administrator Command Prompt (CMD) window and type:

```
netsh interface ipv4 add address "Local Area Connection" 192.168.0.2  
255.255.255.0
```

The above command adds the IP Address 192.168.0.2 (with Subnet Mask 255.255.255.0) to the connection titled "Local Area Connection".

You will then be able to connect to the unit with its default IP.

Note: The secondary IP address is permanent for the LAN connection; don't use it if you only need it once. Instead use the routing table method above.

SP2+ Dual Power Input Option

SP2+ can be powered via dual AC or DC inputs, providing redundancy for powering the device. The 12-24VDC or 48-60VDC external power supplies feature dual DC inputs with a single 5VDC output for powering the SP2+.

Ideal for telecoms applications where DC power comes straight into the cabinets. Or in a data center with dual PDU's. Utilize 2x 12VDC power adapters, one on each AC power source, connect them to the DCW024-5 with the output to the DC jack on the SP2+. If you have the SP2+ with Power over Ethernet (PoE), this can function as a redundant power source. Should the mainline power fail the SP2+ will switch to using the PoE as an alternative power source to the DC jack input.

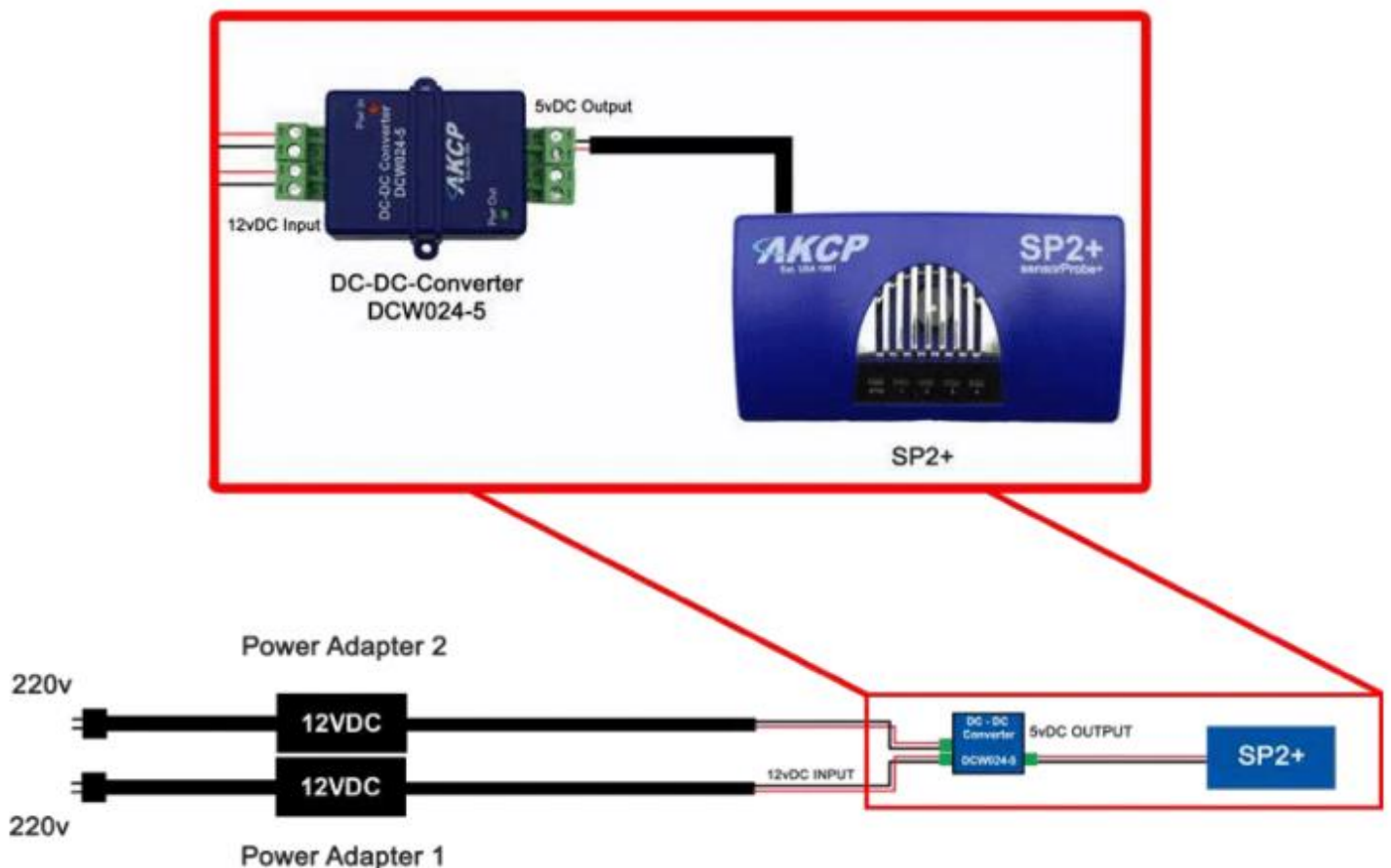

SP2+ Web UI Walkthrough

Menu navigation

With newer firmware (after 1.0.3074), the Web UI and the menu structure has been changed on all SP+ family devices.

To open the menu, click on the three horizontal lines in the upper left corner:

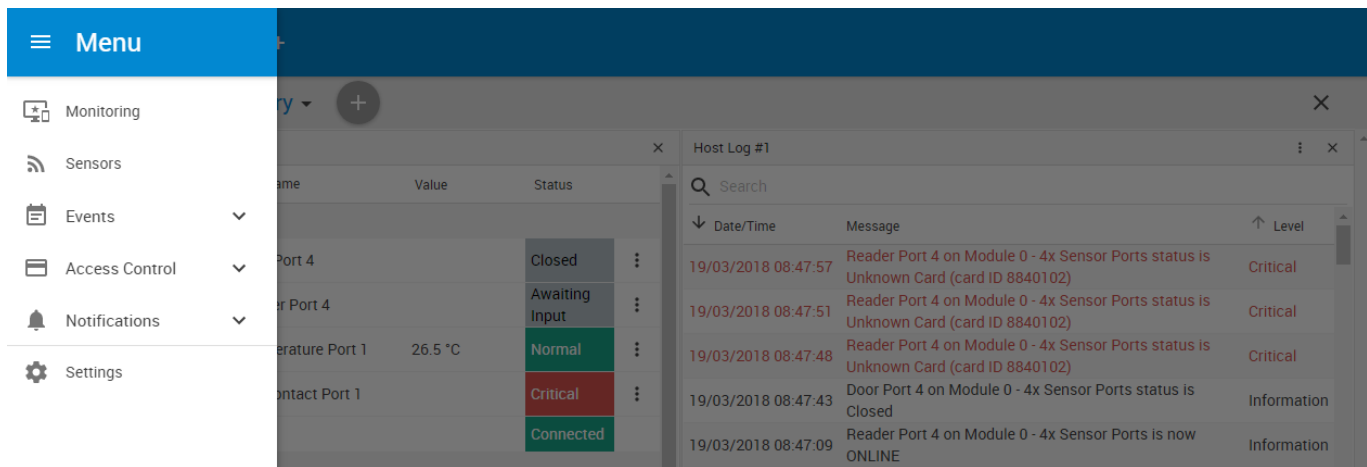

This will bring up the full menu for navigation.

Depending on the device, you might see additional menu items, such as Power.

Important Note:- As Microsoft no longer supports the Internet Explorer web browser, we also do not support any version of IE when viewing our web interface on all AKCP base units. Please use the Chrome or Firefox browsers when viewing the base units web UI.

Monitoring Summary page

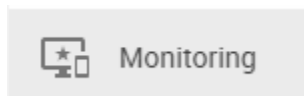

The screenshot displays the AKCP SP2+ Summary page. On the left, a sidebar shows the device hierarchy: [SP2+E] EXP Buzzer .185 (10.1.1.185), Main board, Internal Board, and Virtual Sensors. The main content area is titled 'Workspace > Summary' and shows a table of sensor status for the 'SP2+' device. Below the table is an event log with columns for Date/Time, Message, and Level. At the bottom, a 'Temperature Port 1' graph shows a live temperature reading over time.

Unit	Name	Value	Status
SP2+			
Main board	Siren Port 2		Off
Main board	Temperature Port 1	25.5 °C	Normal
Internal Board	Buzzer		Off
Virtual Sensors			Connected

Date / Time	Message	Level
04/06/2018 14:39:20	Siren Port 2 on Main board status is Off	Critical
04/06/2018 14:14:57	Mod temp2 238 on Virtual Sensors is now OFFLINE	Information
04/06/2018 14:14:47	Mod temp2 238 on Virtual Sensors is now Disabled	Information
04/06/2018 14:14:38	Mod temp 238 on Virtual Sensors is now OFFLINE	Information
31/05/2018 14:07:06	Firmware uploaded successfully from IP: 10.1.1.98. Updating...	Notice
30/05/2018 14:36:31	Restore backup failed because it is not compatible with the device	Critical
18/05/2018 13:35:05	Firmware upgrade was successfully completed	Notice
18/05/2018 13:35:04	Backup successfully restored	Information
18/05/2018 13:34:00	Firmware uploaded successfully from IP: 10.1.1.98. Updating...	Notice

Temperature Port 1 (Live)

From: 05/06/2018 10:39:52
To: 05/06/2018 11:39:52

The graph shows a temperature reading that starts at approximately 25.0°C, rises to a peak of about 25.5°C between 10:48 and 10:57, and then remains stable at 25.5°C until 11:39.

This is the Summary page with Sensor Status and the Event Log, with the Temperature Sensor Graph enabled.

Host Log

The Host Log contains all entries from the “All Events” category. We’ll explain the different categories in the Notifications manual.

The last 30 entries are shown, but if you’re scrolling down the list, more events (30 more) will be loaded automatically. You can view the full log if you keep scrolling down.

In the Summary page’s Sensors Information window you can do the following:

Workspace > Summary +				Host Log #1
Unit	Name	Value	Status	Search
SPX+				
Module 0 - 4x Sensor Ports	Temperature Port 1	26.5 °C	Normal	15/03/2018
Module 1 - 20x Dry Contacts IO	Dry Contact Port 1		Critical	15/03/2018
Virtual Sensors			Connected	15/03/2018
CCU (0D000037)				
CCU 1.2	Cabinet Door Port 1		Forced Open	15/03/2018

Click on the configuration menu button directly next to the right of a sensor to access its popup menu.

Sensor Error	View Graph
Normal	Enable Graph
Off	Acknowledge
Connected	Offline
	Settings

Directly acknowledge a sensor's status, and put the sensor offline

Off	Sensor Control
Normal	On
Off	Off
Connected	Toggle Off-On
	Toggle On-Off
	View Graph
	Enable Graph
	Acknowledge
	Settings

Control the relay-type sensors

View Graph
Disable Graph
Acknowledge
Settings

Enable/disable graph data collection per sensor (if they support it), and display the graph display window for the Summary page
We'll explain the Graph feature in more detail below.

Graph feature

After you've enabled the data collection for a sensor, you can choose to display specific time intervals of the stored data: hourly/daily/weekly/monthly and custom display interval.

You can also export the recorded data in multiple formats.

Important: The maximum number of enabled graphs per unit is 14.

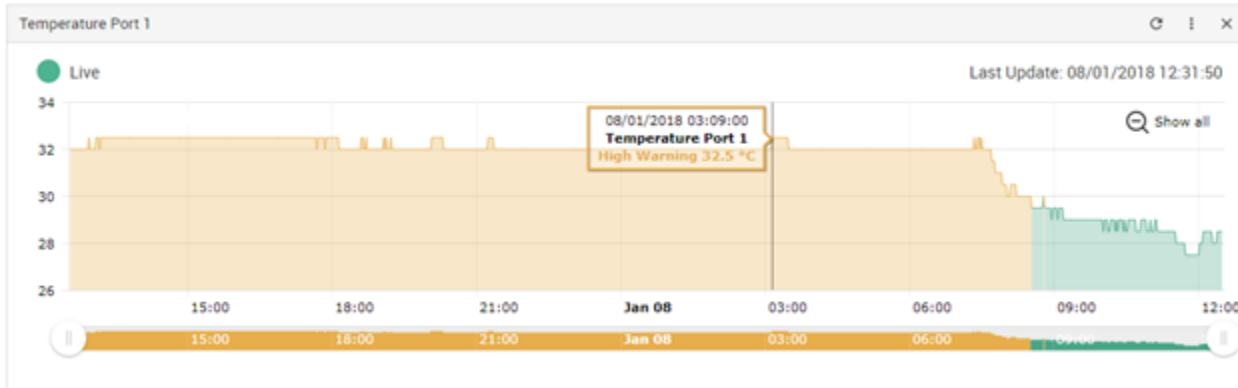

In this example picture, we've chosen to display the temperature sensor's daily maximum.

You could also resize the graph window (including full screen) and move the scale to display more or less data.

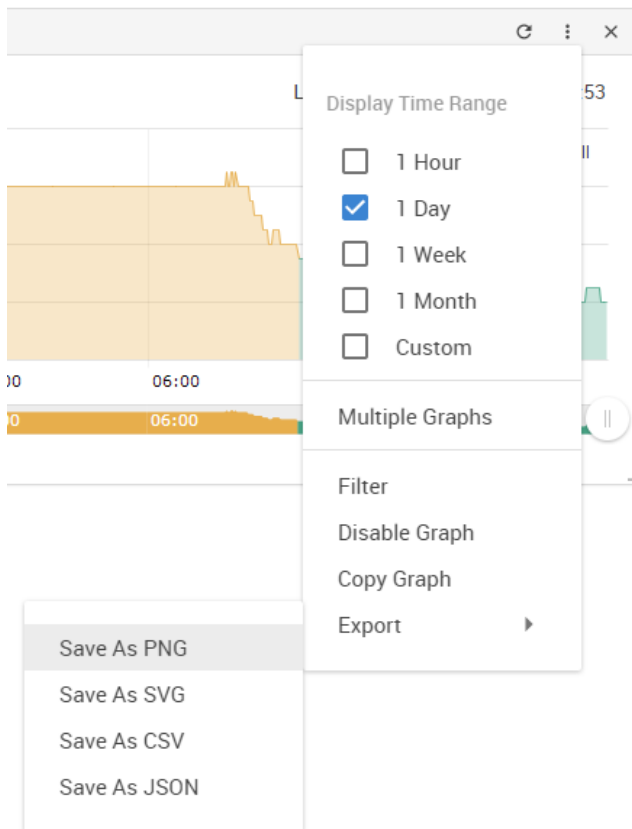

You can choose to export the graph data in selected formats by clicking on the graph's menu on the right, then by choosing the desired format from the popup menu.

The file will be downloaded automatically and assigned a file name that will contain the sensor's name, IP address of the unit, and the date and time.

The graph is always a **Live Graph**; you can set the data collection period in the General Settings page (see below for more information).

You may also refresh the graph data manually with the refresh button on the right.

Graph Data Collection Period

[Graph data can be stored for 31 days 23h 45m 0s.](#)

- Sensor Control
- On
- Off
- Toggle Off-On
- Toggle On-Off

- View Graph
- Enable Graph**
- Acknowledge

- Settings

If you want to view multiple sensor graphs, first you need to **Enable Graph** for a sensor that supports graphing from the sensor's menu. Then select **View Graph** to display it. The data collection will run in the background even if you don't display the graph.

The second graph will appear below the first graph (you can freely rearrange it).

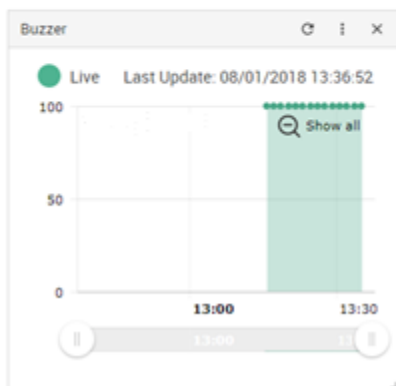
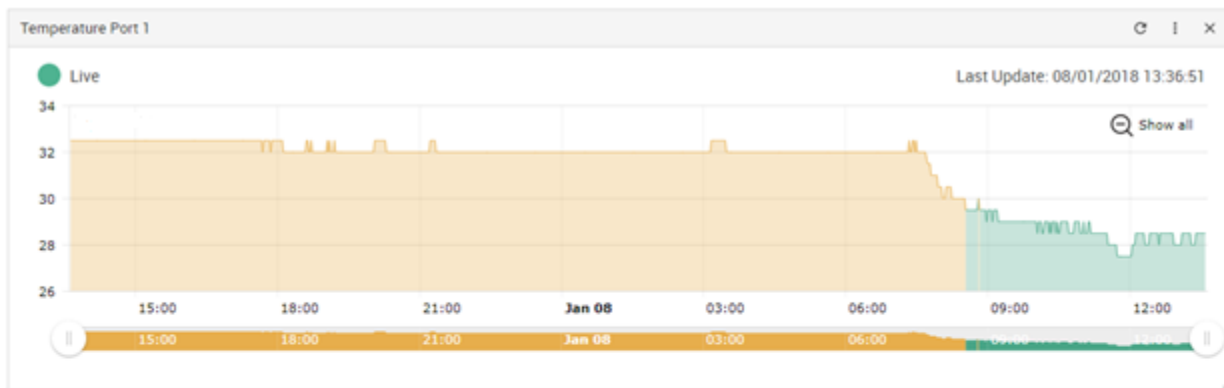

Expansion Units

If you have an expansion unit (or module) connected and sensors on the expansion board, they will be also listed in the System Name Information window as shown below. If you have a BEB unit, please refer to that separate manual titled SPX+ BEB Units. BEB units are NOT supported on the SP2+, only on the SPX+ units. E-sensor8 & E-opto16 expansion units are supported on the SP2+.

System Name (System Location)				Host Log #1
Module 0 - 4x Sensor Ports	Door Port 4		Closed	
Module 0 - 4x Sensor Ports	Reader Port 4		Awaiting Input	19/03/2018 09:51
Module 0 - 4x Sensor Ports	Temperature Port 1	26.5 °C	Normal	19/03/2018 08:41
Module 1 - 20x Dry Contacts IO	Dry Contact Port 1		Critical	19/03/2018 08:41
Virtual Sensors				19/03/2018 08:41
CCU (0D000037)				19/03/2018 08:41
CCU 1.2	Cabinet Door Port 1		Forced Open	19/03/2018 08:41
CCU 1.2	Cabinet Door Port 1 (Reader 2)		Awaiting Input	19/03/2018 08:41
CCU 1.2	Temperature Port 1	26 °C	Normal	19/03/2018 08:41

Temperature Port 1	
● Live	

In the picture above we have a CCU (Cabinet Control Unit) connected as an expansion board, with an additional Temperature Sensor connected to one of its ports.

The base unit (listed as System Name) can be changed by clicking on the link also has a Temperature Sensor connected to Port 1.

Please also check our online sensorProbe+ Knowledge Base using this directly link here, or the QR code below regarding details on how many total sensors and expansion modules :

<https://www.akcp.com/knowledge-base/sensorprobe-plus-series-knowledge-base/>



Managing Desktops and Maps

The updated SP+ Web UI has the Workspaces feature from the AKCPro Server's HTML5 UI. With this you can manage and view different Desktop layouts in a quick and easy way, create multiple custom Desktops as well as select from pre-defined layouts with placeholders for displaying your sensor gauges, logs etc.

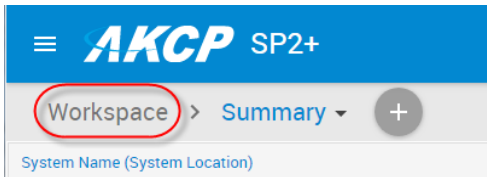

To enter into the Workspace mode, click on the Workspace link circled in red as shown above.

The default Desktop is the Summary page on all devices.

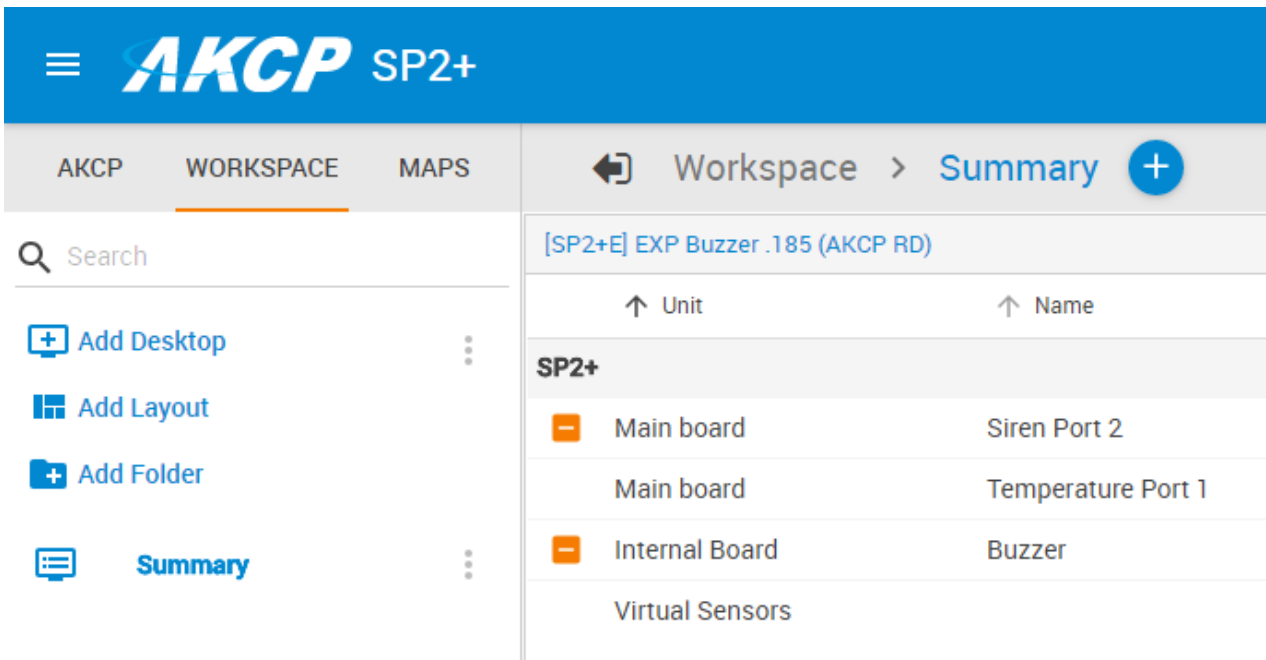

We did add a new built in Map Feature (not the Rack Maps detailed below) which you can use to map sensors in your data center or any other facility.

Please use the link below to download the manual for setting up the maps on your sensorProbe+.
<http://www.akcp.in.th/downloads/Manuals/SP2+/sensorProbe+%20and%20WTG%20Map%20Manual.pdf>

If you find this limiting, you can also use our AKCPro Server for advanced mapping which can be downloaded from this link here:

<https://www.akcp.com/akcp-products/akcpro-server/>

Important Notes on custom desktops

Please note the custom Desktops that are created **ARE NOT** stored in the SP+ units memory. These are HTML based, so they are stored in the browser cache, or local data on the Chrome & Firefox browsers. In other words, the Workspaces are not portable.

So, if you factory reset the unit or clear the cache on your internet browser the folders and custom desktops will be lost.

Generating a backup file from the Maintenance menu will also contain the custom desktops (added after firmware version 1.0.4209).

Without generating a full backup file, you could to export and then import the desktop configuration before you change browser, change your device or before you clear your browser cache. The configuration files will be saved as JSON files.

You can click the Export / Import command on a Desktop to save/reload it individually:

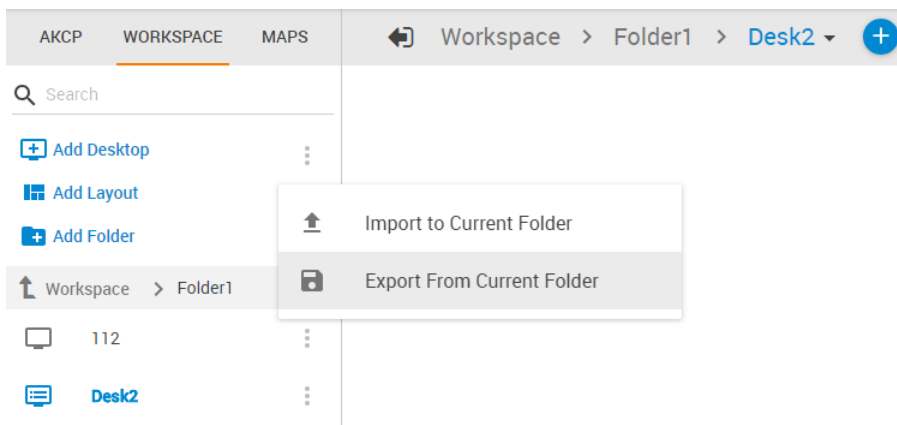

Viewing custom desktops different users & PC's

Regarding the viewing of your custom desktops via other users. Because multiple users can log into the SP+ unit from the same PC or different PC's on the network, the following applies:-

If two different users (different usernames) log in to the same SP+ unit they will not be able to view the other users custom desktops.

If the same user logs into the SP+ from two different PC's they will not be able to view the custom desktops (they do not synchronize), so the custom desktops will only be viewable on the original PC that they were created on as again these are stored on the PC's browser local data.

Managing Desktops

Navigation

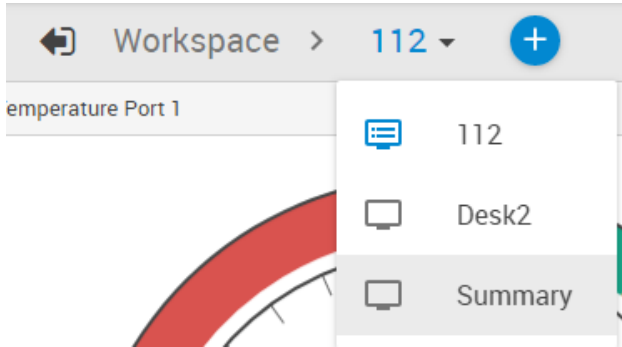

You can manually change between Desktops using the arrow menu, or by directly clicking on the desired Desktop if they are stacked under a folder.

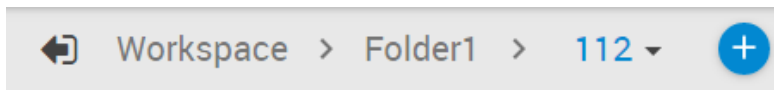

With this button, your current Desktop will expand to the browser's screen width as shown on the screenshot below:

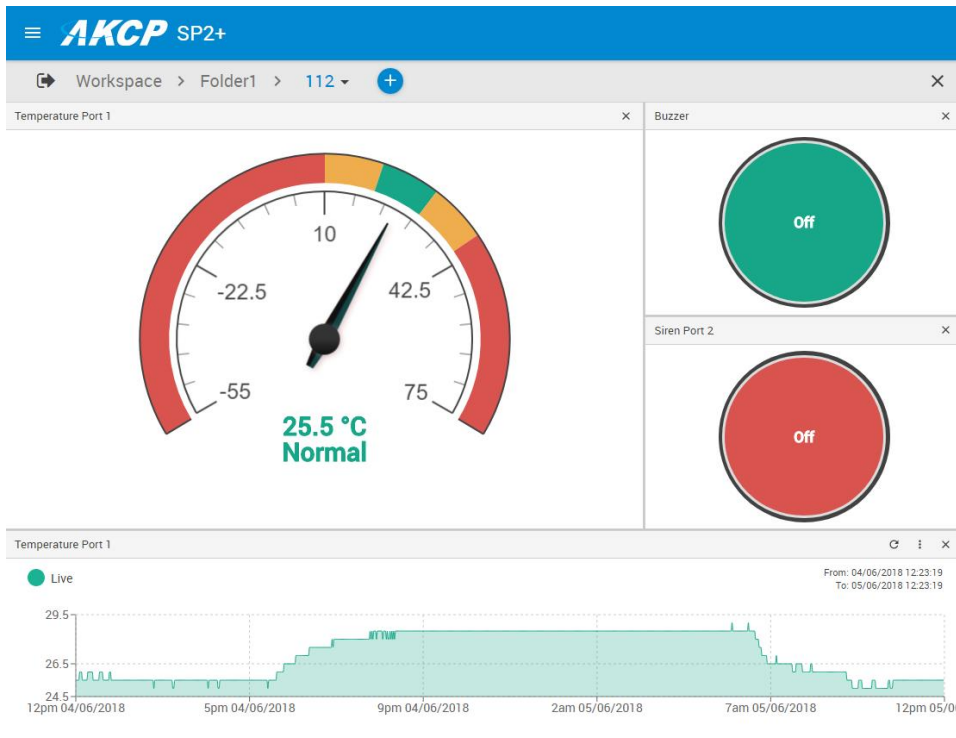

Click it again to go back to the full view.

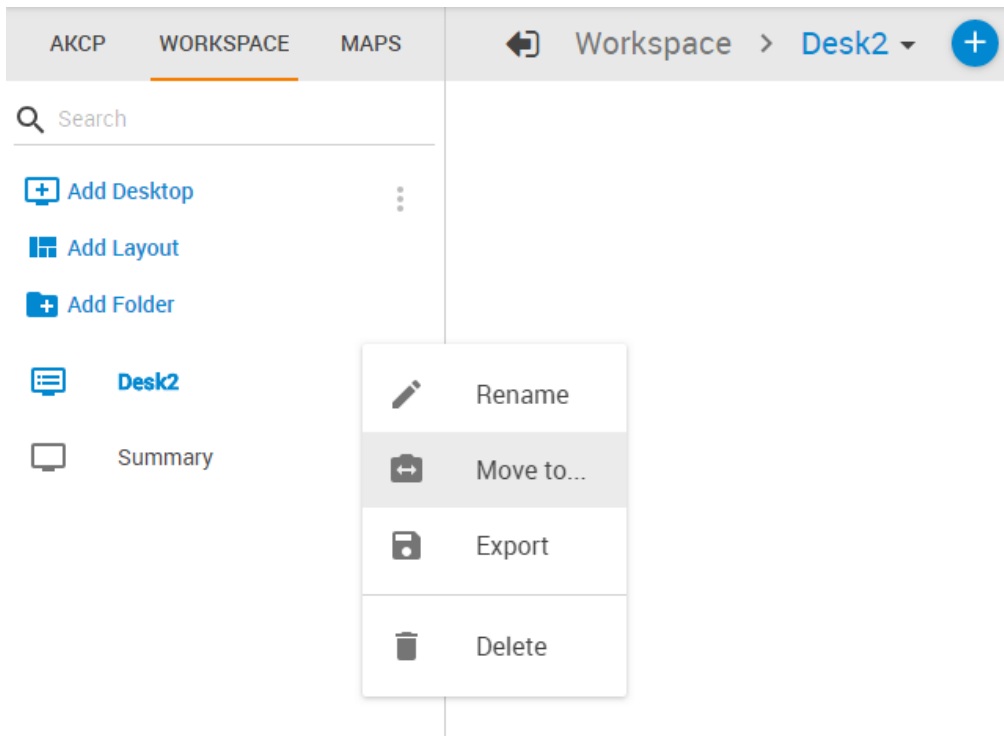

On each Desktop and Folder item, you have the option to Rename, Move, Export or Delete them. Move is useful if you've created multiple folders (see below). As noted earlier, don't forget to export your Workspace items to save them permanently.

Folders

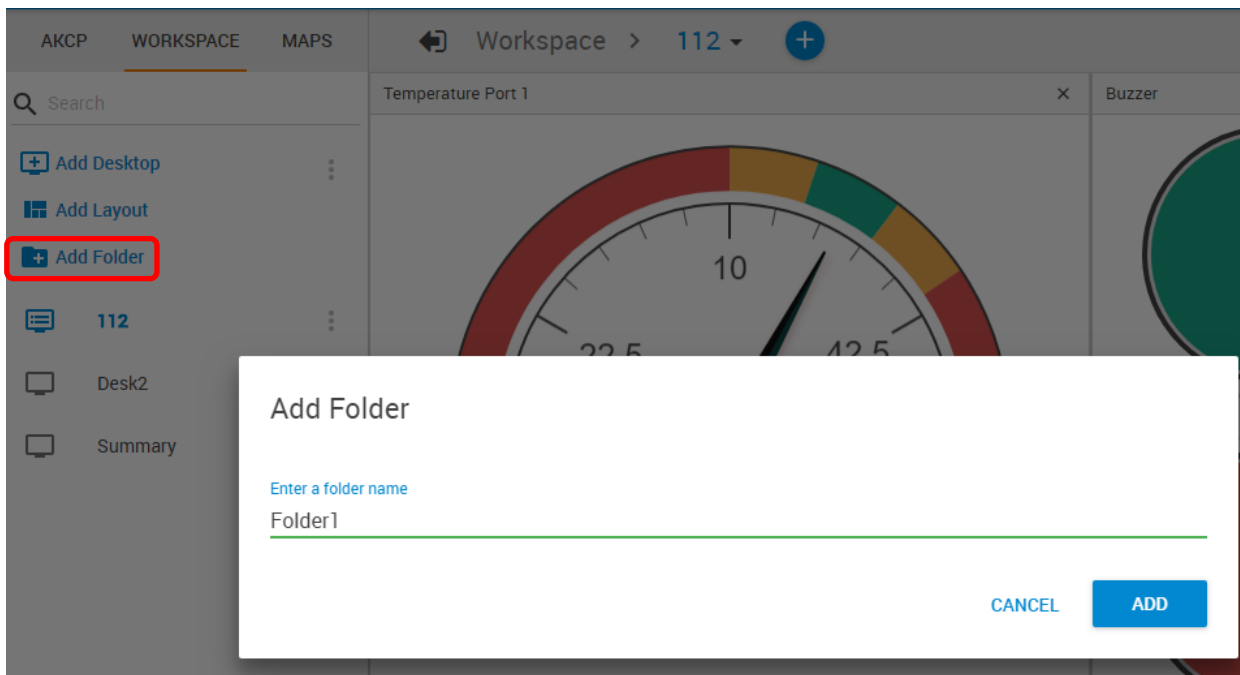

You can add Folders to arrange your desktops into a hierarchical view.

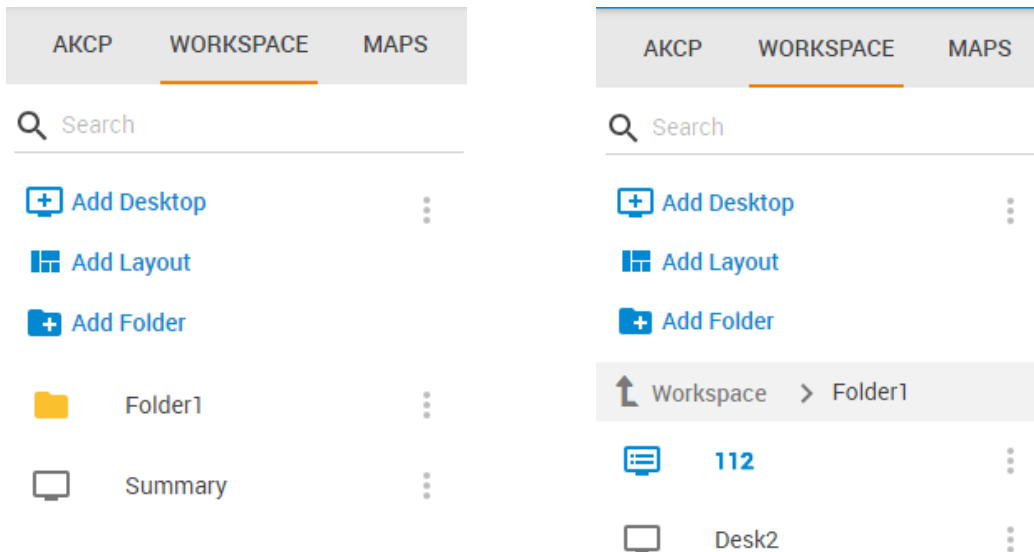

After created, you can simply drag and drop your Desktops under the folder, or use the Move menu. The folder structure will also display on the Desktop selector menu on top:

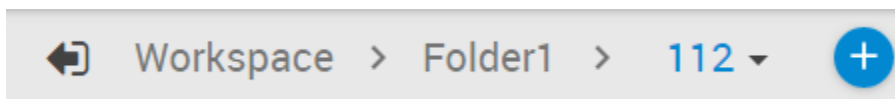

Desktops

You can add new Desktops where you can customize the layout to place any sensor gadget, logs, graphs etc. on the screen.

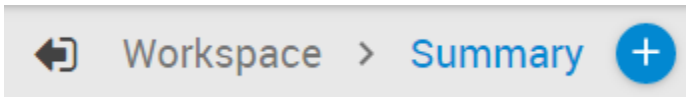

There are two ways to add a new desktop. The first is by creating a blank desktop using the **Add Desktop** link under the Workspace tab:

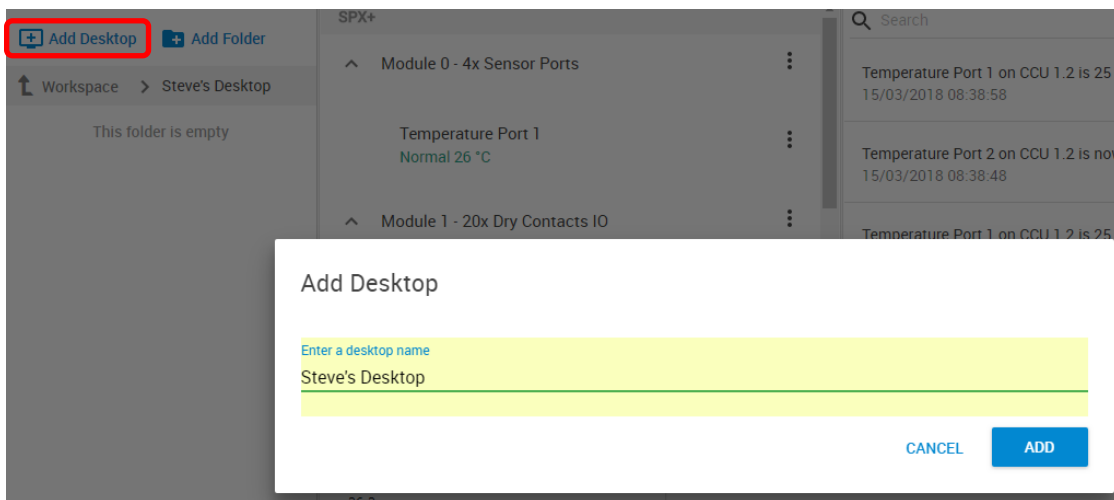

Name the new desktop and click the **Add** button.

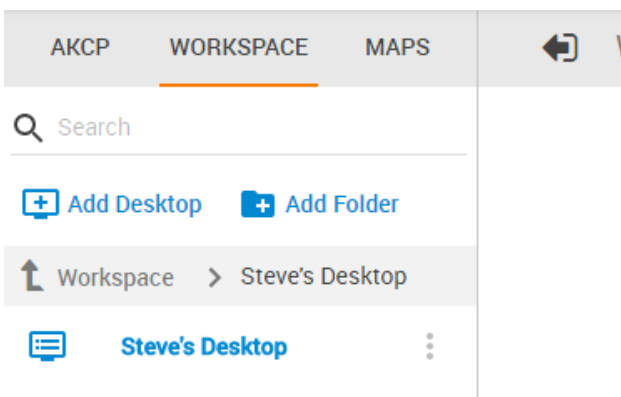

It will appear in the Workspace menu list.

In addition to the simple blank desktop, the second way to add a new desktop is via pre-defined Desktop Layouts. You could choose one that best suits your monitoring needs to drag and drop your sensor gadgets.

Use the plus button at the top of the page and select the layout for your new desktop:

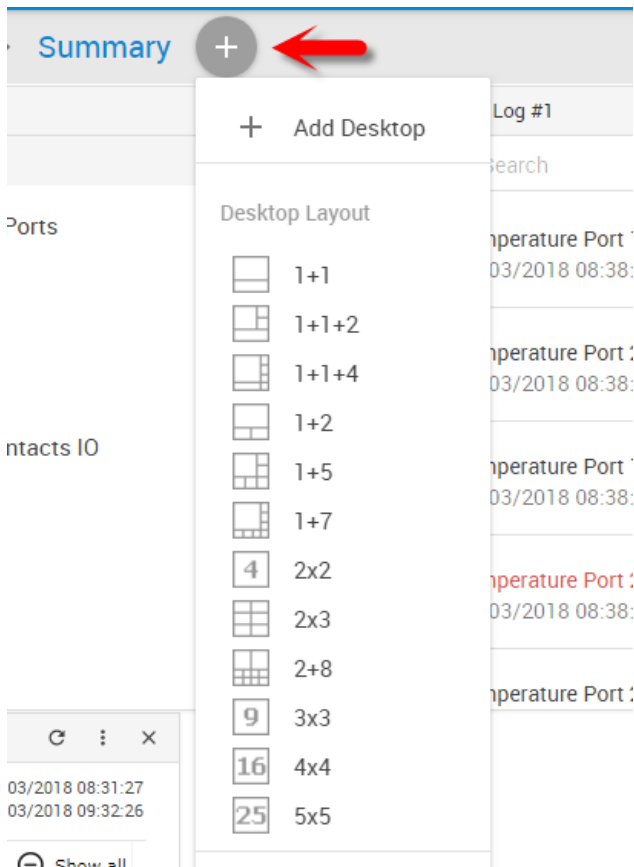

Alternatively you can click on the Add Layout link to select from layouts:

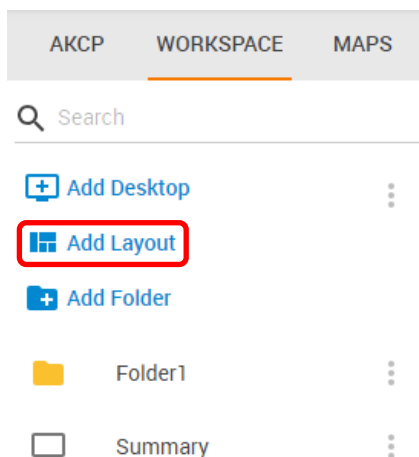

The empty desktop will have placeholders similar to this:

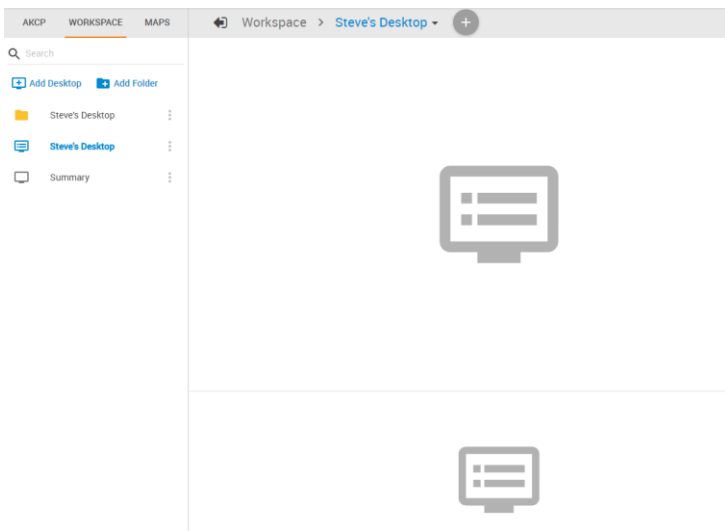

As an example below, we've selected the 1+1+2 layout. Then you can drag and drop sensors, logs and graphs on the layout:

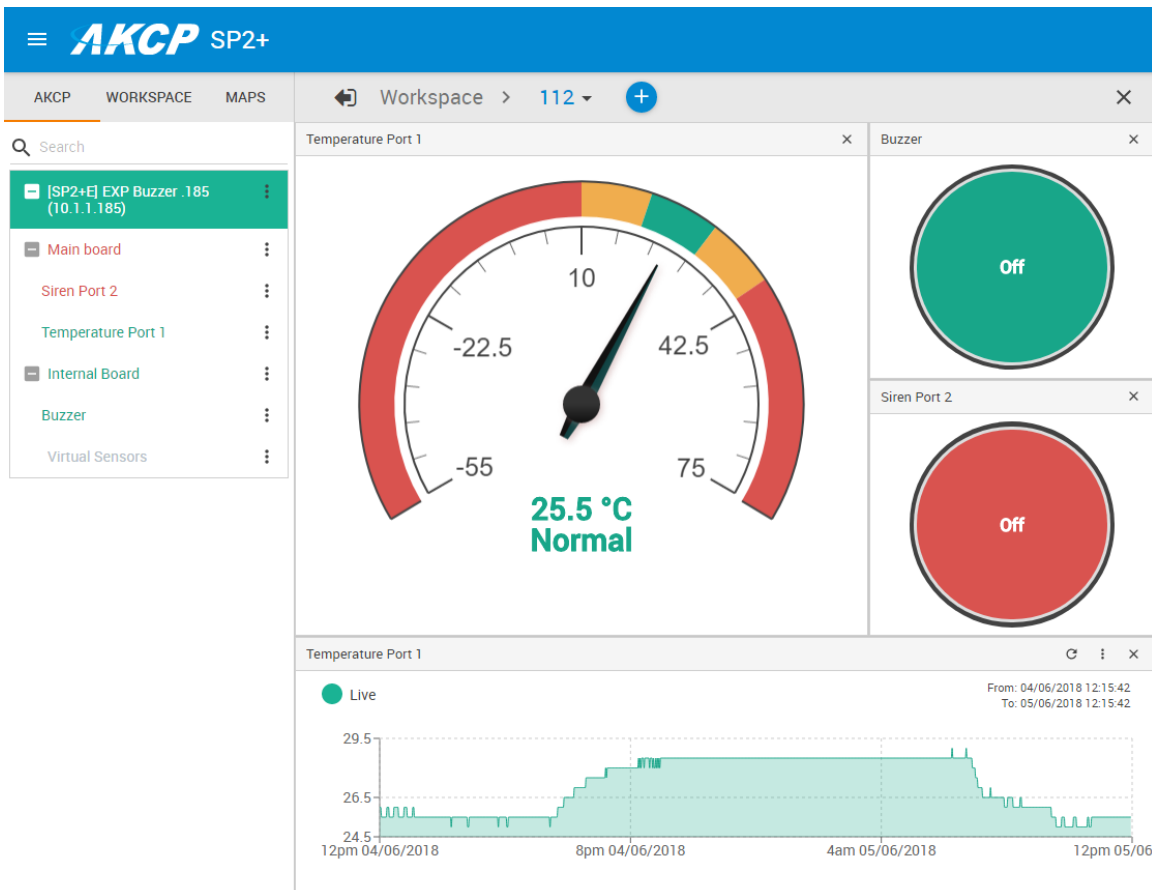

Below we'll show you how you can add sensors to the desktops.

Adding items to your custom desktop

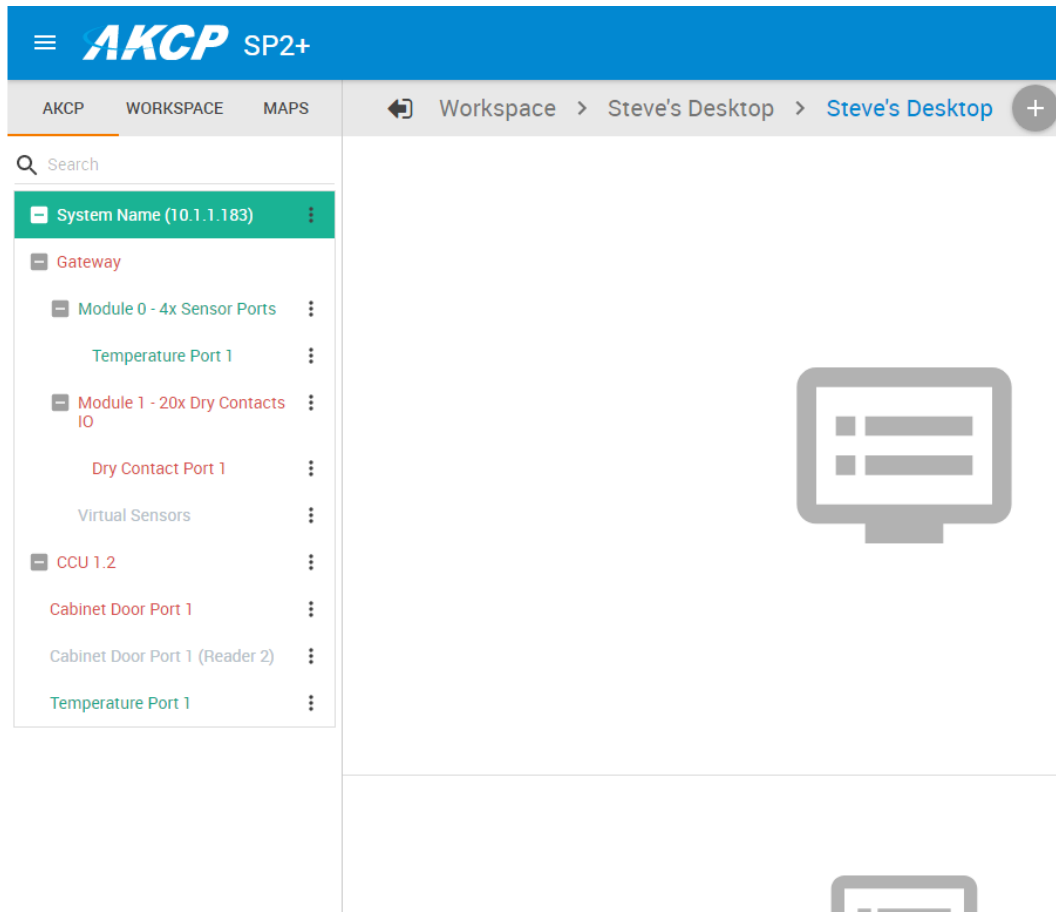

To add items from the units that are connected to the SP+ unit, you will first need to click on the AKCP link in the Navigation Tree as shown above.

Next simply drag and drop the items you wish to add to your new desktop. This is also how you can add items to the Summary page. To navigate back to the Summary or Main Monitoring page click on the Summary link shown below.

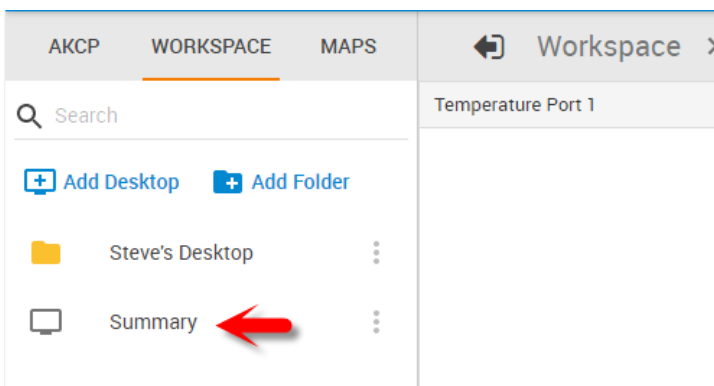

Desktop Auto Scroll feature

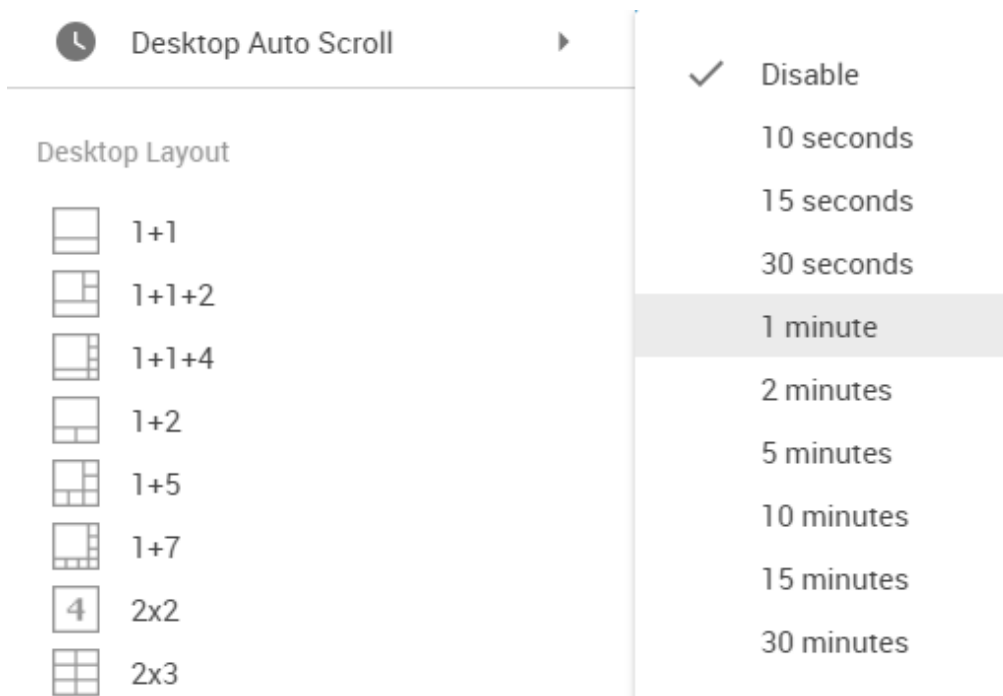

With this feature enabled, your desktop view will automatically switch between the created additional desktops within the specified time interval.

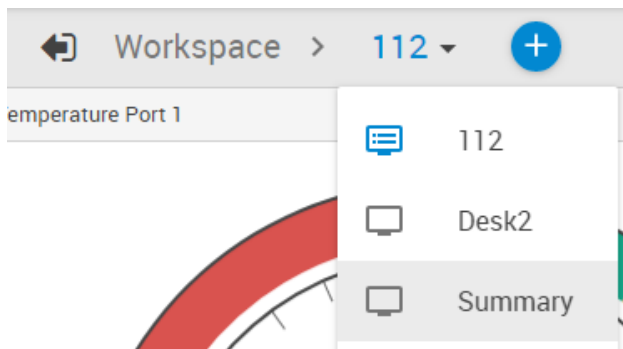

You can also manually change between Desktops using the menu.

Managing Rack Maps

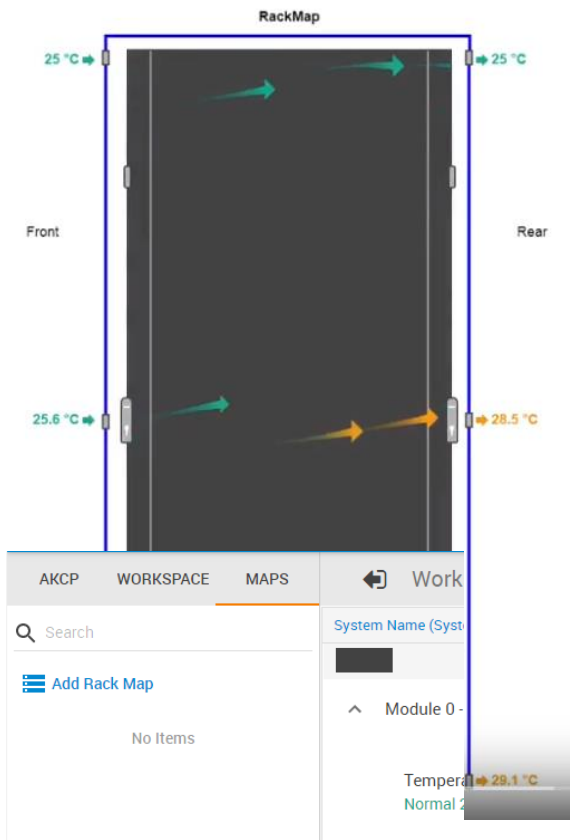

The Rack Map feature was originally (and still is) included in the AKCess Pro Server / AKCPro Server (HTML5) and has also been added to the SP+ units. You can add a Rack Map as a graphical representation of your server rack, and to display and record the temperature of the airflow within your server cabinets.

Note that on SP+ family Web UI only limited options are available for the Rack Map; for example you cannot add devices or assets.

Click on the Maps tab and Add Rack Map link to add a Rack Map:

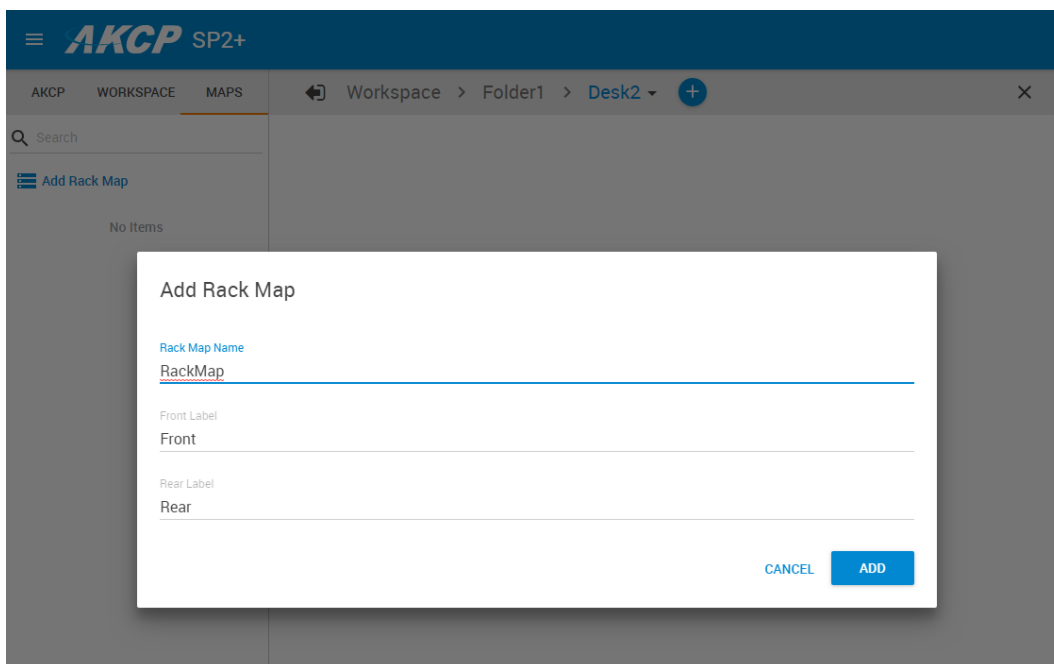

After created, you can drag and drop the Rack Map to a desktop.

You can add Temperature sensors, the Swing Handle Lock and the Sensor Status Light gadget on a Rack Map. Simply drag and drop the desired sensor from your unit's sensor list, as shown below.

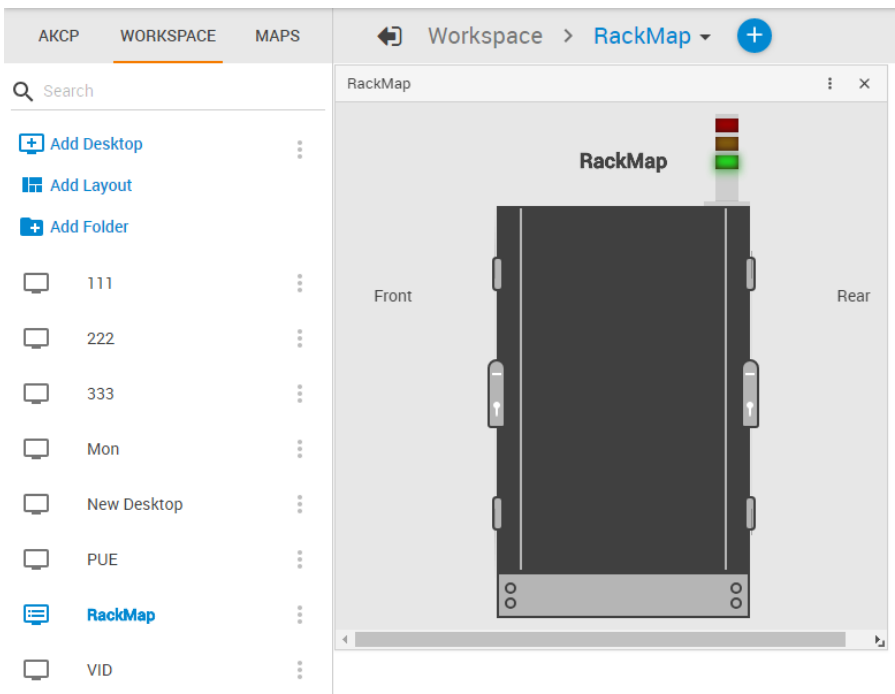
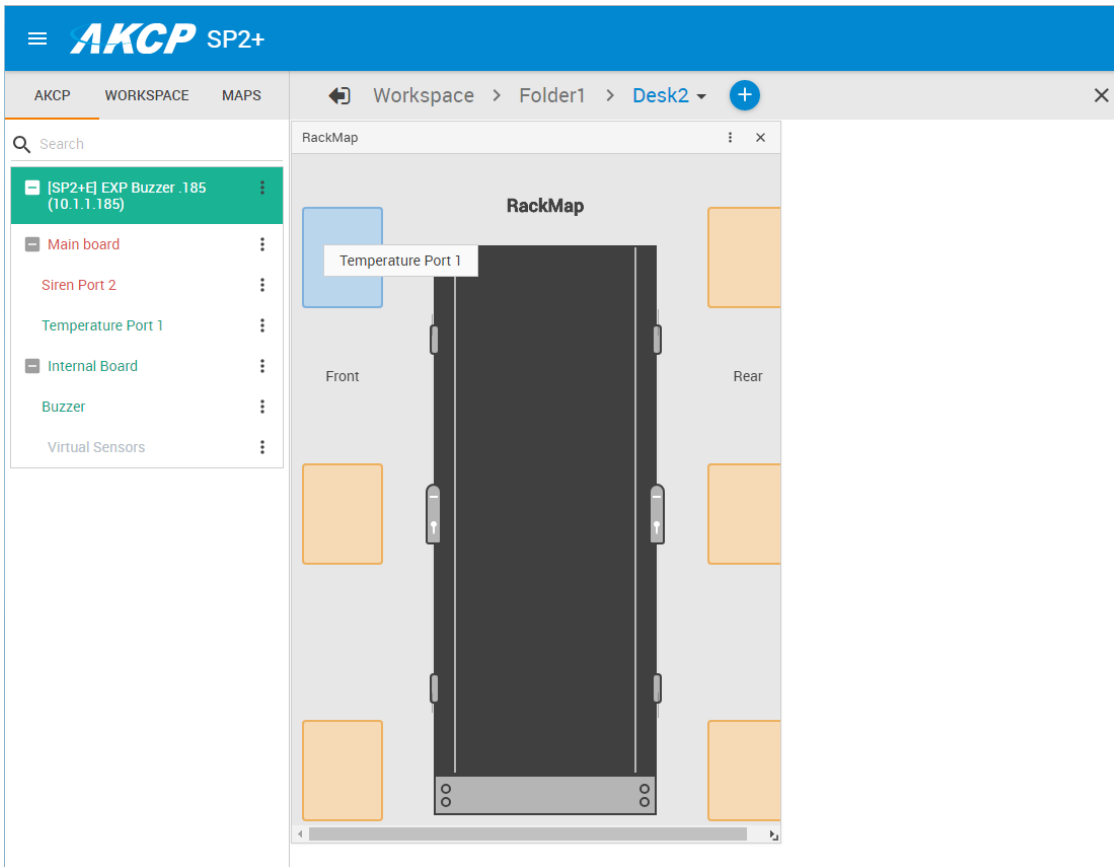

This example picture shows a Sensor Status Light added to a Rack Map.

Please see the Thermal Map sensor manual for complete installation & setup instructions for the Thermal Map sensors.

Access Control Users and Groups

- Access Control
- Users
- Groups
- Time Schedules
- Holiday

The Access Control Users and Groups are managed from the AKCPro Server and are used for accessing doors with the Swing Handle Lock. You can only view the existing users and groups from the unit's Web UI and modify only a few parameters on them.

Users
Access Control / Users

Search

↑ First Name	↑ Last Name	Group	Card ID	
Admin	Admin	(None)	-	
Jo	Jo	(None)	-	
mot	mot	(None)	-	

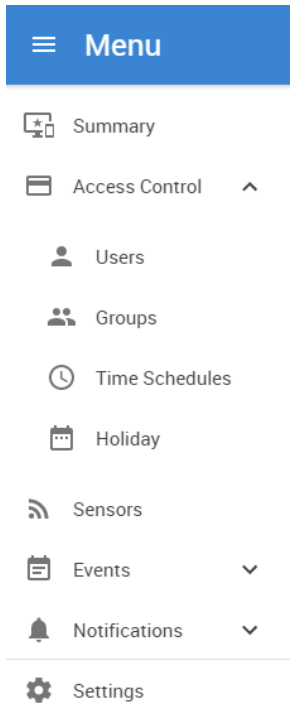

This feature has its own manual, refer to the SP+ Swing Handle Lock Manual for more information.

Notifications and Events

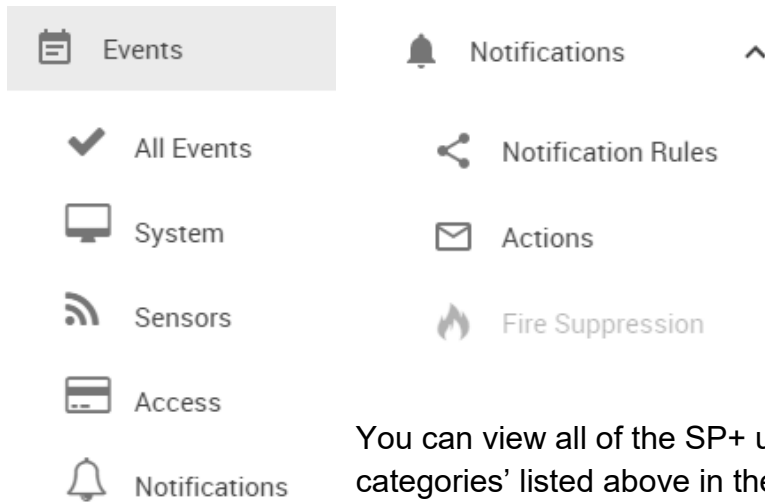

You can view all of the SP+ unit's events and filter them by each of the categories' listed above in the Events drop down menu.

Please refer to the SP+ units "Notifications Manual" for setting up the alerts and the Event log on the units.

The Sensors menu

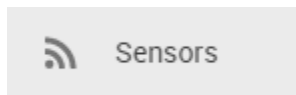

The "Sensors" shortcut will allow you navigate directly to the sensors setting page where you can setup the sensors connected to the unit. This is covered in the Sensors section in this manual.

The Settings menu

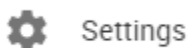

This shortcut will take you to the unit's system settings pages. Each page will be described below in detail.

System page

General

System

- General
- Date/Time
- Network
- Modem
- VPN
- SMTP
- SNMP
- Server Integration
- Services
- Modbus
- Password Checking
- Maintenance
- Heartbeat Messages
- License Management
- About

General

System / General

System Description SP2+ 1.0.4034 Dec 19 2017 15:17:28

System Name [SP2+E] EXP Buzzer .185

System Location AKCP RD

System Contact Charles

System URL http://www.example.com

Sensor Notification On System Boot Up On Off

Graph Data Collection Period 90 1m 30s
Graph data can be stored for 31 days 23h 45m 0s.

Language English Manage

Save Cancel

Get SNMP OID

Here you can change general settings for the device.

The unit's firmware version is shown in the Description field, and the System Name/Location/Contact options are user configurable. You could also specify the System URL option, for quick access of a custom part of the Web UI for example, but you can specify any URL.

With newer firmware you can also specify GPS coordinates.

Graph Data Collection Period 777 12m 57s

Graph data can be stored for 165 days 18h 14m 24s.

⚠ Changing this parameter will clear the graph data.

Save Cancel

By changing the **Graph Data Collection Period**, you can choose how frequently the data is sampled. Note that if you had stored graph data previously, changing this setting will clear the data.

With the option **Sensor Notification On System Boot Up**, you can choose to allow/disallow running the notifications with sensor values read at system boot up. In some cases, invalid values are read while the unit is starting up, and you could get false alarm notifications. You can enable/disable the notification processing at startup with this option.

On each System subpage you can see a **Get SNMP OID** button (where applicable):

Get SNMP OID

SNMP OID of General

Description ▲	Syntax ▼▲	Access ▼▲	SNMP OID ▲
cfgSystemDescription	DISPLAY STRING	read-write	.1.3.6.1.4.1.3854.3.2.1.8.0
cfgSystemName	DISPLAY STRING	read-write	.1.3.6.1.4.1.3854.3.2.1.9.0
cfgSystemLocation	DISPLAY STRING	read-write	.1.3.6.1.4.1.3854.3.2.1.10.0
cfgSystemContact	DISPLAY STRING	read-write	.1.3.6.1.4.1.3854.3.2.1.11.0
cfgGraphDataCollectionPeriod	INTEGER	read-write	.1.3.6.1.4.1.3854.3.2.1.104.0
cfgSystemURL	DISPLAY STRING	read-write	.1.3.6.1.4.1.3854.3.2.1.107.0

This will give you a popup window with all relevant OIDs for the actual page (here the General page is shown).

You can use OIDs for SNMP calls and in custom scripts, or for setting up the unit for monitoring by a third party NMS software such as WhatsUpGold or Paessler.

This button is also accessible on the *Sensors page* for each sensor.

Language management

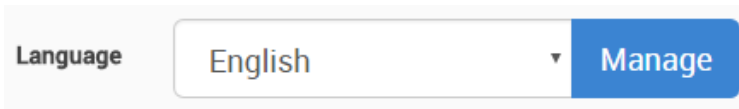

You can change the display language of the Web UI with this option. Only one additional language is supported, together with the default (and fallback if there's an error) English.

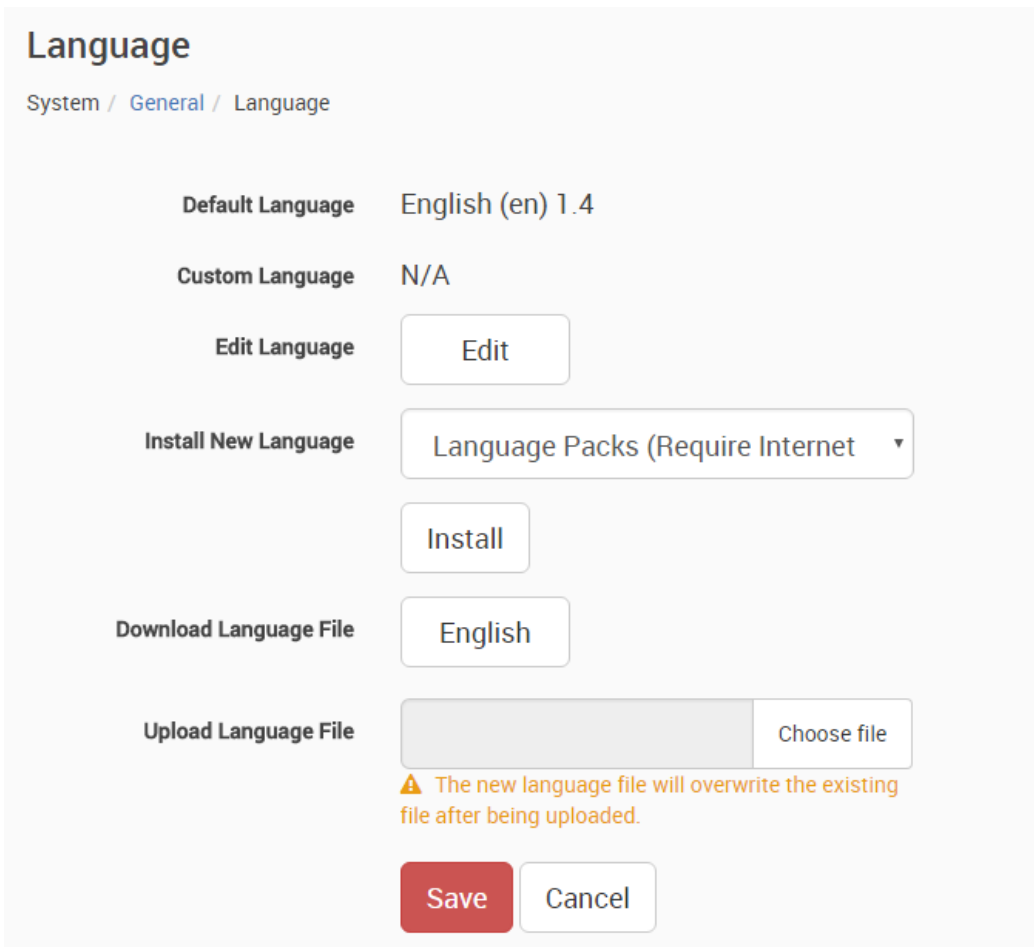

In **Manage**, you can choose to **Download Language File** if you'd like to edit the language file offline (you can also download the custom language's file if it's already present). Then upload the completed file, and it will be selectable as the Custom Language. For official translation files, the language code and version will show the correct values.

Note: Whenever you upload or install a custom language file, it will overwrite the old file. Only one additional language is supported.

You can get separately downloadable language files from our website in the Support section.

If you have active internet connection, the unit supports installing the official language files directly from our server.

Select a language from the drop-down menu **Install New Language**:

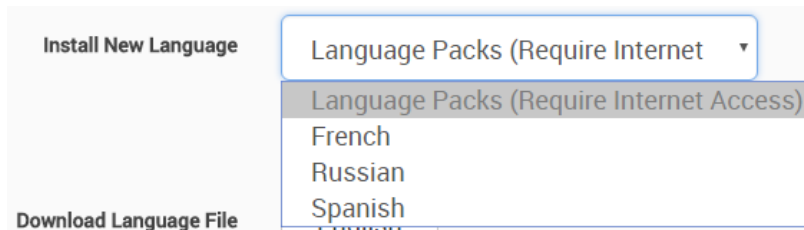

Then press the **Install** button. It will ask you to confirm the action in a popup window:

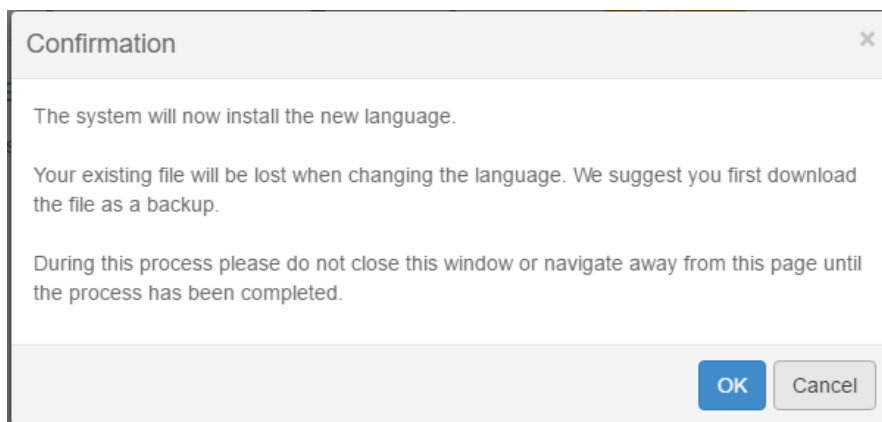

Wait until the language is downloaded and installed:

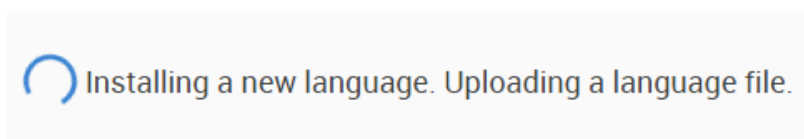

The unit will notify you about the successful language installation. If you installed it from the list, it won't change the language of the Web UI automatically.

Now you can switch display languages by selecting from the drop-down list on the **General** page, then pressing **Save**:

Language English Manage

English

Spanish

After you've added the custom language, you can manage it from the same menu:

Language

System / General / Language

Default Language English (en) 1.4

Custom Language Spanish (es) 1.4

Edit Language Edit

Install New Language Language Packs (Require Internet)

Install

Download Language File English Custom

Upload Language File Choose file

Save Cancel

Warning: The new language file will overwrite the existing file after being uploaded.

Note: The official language files are also included in the firmware update packages.

You can also edit the chosen language directly in the Web UI, if you choose **Edit Language**:

Custom Language Spanish ▼

Save Cancel

Group	Total Entries	Translated Entries	
General	110	110	Edit
Setup	25	25	Edit
Code Activation	9	9	Edit
Menu	33	33	Edit
Explorer	3	3	Edit
Gadget	97	97	Edit
Login	6	6	Edit
Sensor Setting	519	519	Edit
Event	120	120	Edit
Notification Type	21	21	Edit
Action Selection	2	2	Edit
Sensors Control Action	6	6	Edit
Relay Action	15	15	Edit
Dry Contact Action	15	15	Edit
Siren Action	13	13	Edit
Door Action	16	16	Edit

Date/Time

The screenshot shows the 'Date/Time' configuration page in the AKCP SP2+ web interface. The sidebar on the left contains various system settings categories. The main panel displays the following configuration options:

- Timezone:** (GMT+07:00) Bangkok, Hanoi, Jakarta
- Date/Time:** 11/01/2018 10:55:56
- Network Time Protocol:** Continuously
- NTP Server 1:** time.windows.com
- NTP Server 2:** 127.0.0.1
- RTC Battery Status:** Good

At the bottom of the configuration area, there are two buttons: a red 'Save' button and a white 'Cancel' button.

The system date and time with time zone is user configurable, with NTP server synchronization. If the unit is connected to APS (AKCPro Server), then it will sync with the APS NTP service. Also displayed is the status of the RTC battery (good/bad).

F7 units will also let you specify secondary NTP, and secured NTP servers.

This close-up shows the 'Network Time Protocol' dropdown menu. The menu is open, displaying the following options:

- Do not use
- One time
- On system start up
- Once a month
- Once a week
- Once a day
- Once a hour
- Continuously (highlighted)

Below the menu, there are two buttons: a red 'Save' button and a white 'Cancel' button.

You can also select the frequency of NTP synchronization with the drop-down menu.

Network

The screenshot displays the Network configuration interface for the AKCP SP2+ device. The interface includes a sidebar with various system settings and a main configuration area for the network. The network settings are as follows:

Setting	Value
Use DHCP	Disable
IP Address	10.1.1.185
Subnet Mask	255.255.255.0
Default Gateway	10.1.1.2
Domain Name Server	8.8.8.8
Ethernet MAC ID	00:0B:DC:10:01:85

The unit's MAC ID is displayed here, and all user configurable options for IPv4 with fixed IP or DHCP client mode.

F7 units also have IPv6 settings (separately licensed feature), we have a separate manual about this feature.

Modem

The screenshot displays the 'Modem' configuration page in the AKCP SP2+ web interface. The left sidebar contains a menu with the following items: System, General, Date/Time, Network, Modem (highlighted), VPN, SMTP, SNMP, Server Integration, Services, Modbus, Password Checking, Maintenance, Heartbeat Messages, License Management, and About. Below the menu is a 'Get SNMP OID' button. The main content area shows the following configuration options:

- Connection Method:** Never Dial-Out (Use Ethernet Only) (dropdown)
- Connection Type:** Always On (radio), On-Demand (radio, selected)
- Status:** Not Connected
- IP Address:** 0.0.0.0
- SIM Status:** Bad
- Network Mode:** No Service
- Signal Level:** -101 dBm
- Connection Mode:** Normal (dropdown)
- Access Point Name:** Access Point Name (text input)
- Redial Attempt:** 0 (dropdown)
- Idle time before hanging up:** 0 (text input) 0s (text input)
- Login Name:** Login Name (text input)
- Password:** Password (text input)
- ISP's Domain Name Server:** 0.0.0.0 (text input)

At the bottom of the configuration area are 'Save' and 'Cancel' buttons.

If the unit is equipped with the internal modem module, then the modem's **Dial-Out configuration** can be set up here for data connections. Contact your service provider for the correct settings.

You can also see on this page the state of the connection, the **Network Mode** and the assigned IP address when connected, if the SIM card is detected properly by the modem (**SIM Status**), and the **Signal Level**.

Connection Mode	Normal
Access Point Name	Normal
Redial Attempt	PAP:Unsecured PAP:Secured GPRS:Unsecured GPRS:Secured Ras

You may select a different *Connection Mode* (PAP/GPRS/RAS).
The most commonly used is *GPRS Unsecured*.

Connection Method	Never Dial-Out (Use Ether
Connection Type	Never Dial-Out (Use Ethernet Only) Dial-Out If Ethernet failed Use Dial-Out Only

You may change the *Connection Method* as follows:

- *Never Dial Out (Use Ethernet only)*: the unit will never try to use the modem for sending out notifications. If you don't have Ethernet connection, you should change this setting; otherwise you won't get any notifications.
- *Dial-Out if Ethernet failed*: the unit will only use the modem for sending out notifications, if the Ethernet connection fails.
- *Use Dial-Out Only*: the unit will only use the modem to send out the notifications, regardless of the state of the Ethernet connection.

Connection Type	<input checked="" type="radio"/> Always On <input type="radio"/> On-Demand
-----------------	--

Also you may change the *Connection Type*:

- *On-Demand*: the unit will initiate a connection only when it's necessary for sending out the notifications.
- *Always On*: the unit will keep the connection up, even when there is nothing to send.

Note 1: There's no auto-detection feature for the internal modem module, the configuration is always shown even if your unit is not equipped with the module.

Note 2: Only insert and remove the SIM card when the unit is turned off. Otherwise you can damage the SIM and the modem.

Note 3: The PIN code for the SIM card needs to be removed; otherwise the modem can't use it.

VPN

System / VPN

This feature has no license. To request a license click here.

VPN Enable Disable

Status Not Connected

IP Address 0.0.0.0

VPN Server Address

VPN Server Port

VPN Password

Confirm VPN Password

VPN Encrypt Method

This feature requires a separate license. You can read more details about the licensing later in this manual.

This feature is used by connecting the SP2+ with the APS VPN server. After the license has been activated and the APS VPN server is set up, you'll need to fill out the same options here to be able to use the VPN connection (see below).

VPN Encrypt Method

- None
- Blowfish**
- AES
- Triple DES

Note 1: You can also configure these settings from the APS console for the unit.

Note 2: If you use the VPN option, the maximum number of sensors that can be used by the unit will be reduced to 36 on F4 units (no limit on F7).

Set up VPN connection to APS

In the following pages, we'll describe how to set up the VPN connection to APS.

1. On APS HTML, Go to **Settings>Server Settings>Virtual Private Network**

Server Settings

- Connections
- VPN**
- Event Logs
- Notification
- NTP
- LDAP
- Language
- Services

Virtual Private Network

Settings / Server Settings / Virtual Private Network

Enable VPN Server

Status: VPN Server is running

Network Settings

Network Address
192.168.17.0

Subnet Mask
255.255.255.0

Listening Port
1196

Authentication Settings

Network Encryption
AES

Network Password

SAVE **CANCEL**

Enable the VPN Server by clicking on the checkbox, and then change the **Network Password** in Authentication Setting. Remember the **Network Encryption Mode** that you have chosen; you'll need to provide the same setting on the SP+. See more details in the APS HTML manual.

You can also make changes to the network settings, but you'll have to use the same port on both sides of the VPN.

Note: The VPN virtual network has to be an entirely different subnet from the one you're currently using, otherwise it won't work!

Ex. if you're using 192.168.1.x network subnet on your LAN, use 192.168.11.x (or any other that's different from 192.168.1.x) for the VPN link.

You could also configure the VPN settings using the deprecated APS Windows Client interface:
Settings>Server Option>Virtual Private Network

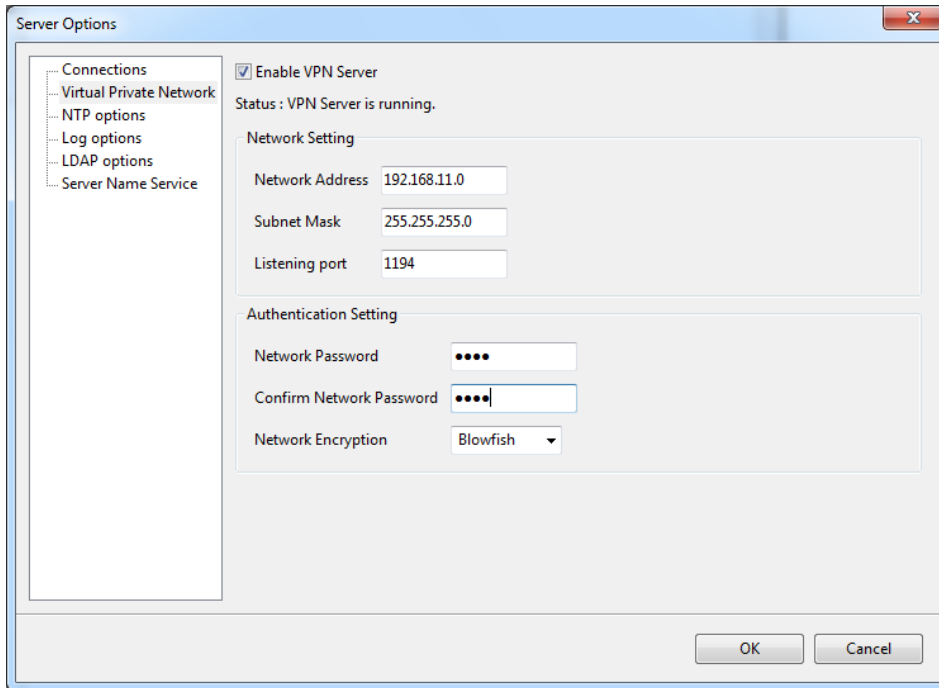

The screenshot shows a Windows-style dialog box titled "Server Options". On the left is a tree view with the following items: "Connections", "Virtual Private Network" (which is selected), "NTP options", "Log options", "LDAP options", and "Server Name Service". The main area of the dialog is divided into sections:

- Enable VPN Server:** A checked checkbox.
- Status:** "VPN Server is running."
- Network Setting:** A group box containing three text input fields:
 - Network Address: 192.168.11.0
 - Subnet Mask: 255.255.255.0
 - Listening port: 1194
- Authentication Setting:** A group box containing three controls:
 - Network Password: A text box with four dots.
 - Confirm Network Password: A text box with four dots.
 - Network Encryption: A dropdown menu set to "Blowfish".

At the bottom right of the dialog are "OK" and "Cancel" buttons.

2. On the SP+ Web UI, enable the VPN

First change the VPN Client on the top to "Enabled" and configure the VPN Settings on the form:

- Specify the AKCPro Server's IP or DNS name in VPN Server Address
- Use the VPN Network Password that you have specified on APS
- Set up the the VPN Encrypt Method on the Encryption tab; use the same setting that you have specified on APS.

After clicking the "Save" button, the unit will ask you to reboot.

After the unit has rebooted and shows "Connected", it will show the VPN client's IP Address.

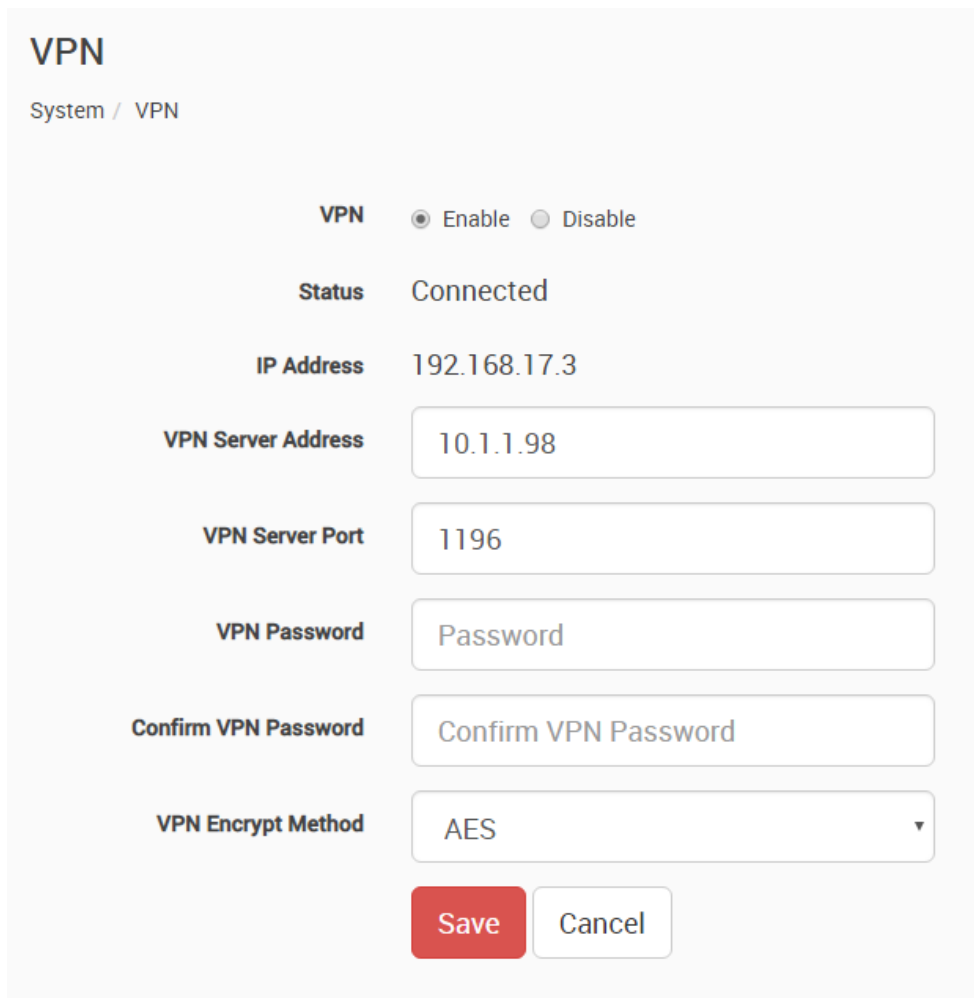

VPN

System / VPN

VPN Enable Disable

Status Connected

IP Address 192.168.17.3

VPN Server Address

VPN Server Port

VPN Password

Confirm VPN Password

VPN Encrypt Method

You can review the unit's syslog to see if there were any errors with connecting to the VPN server.

3. On your APS console, the SP+ unit will be added to the **Server Explorer** automatically, with an IP address automatically assigned from the range you specified.

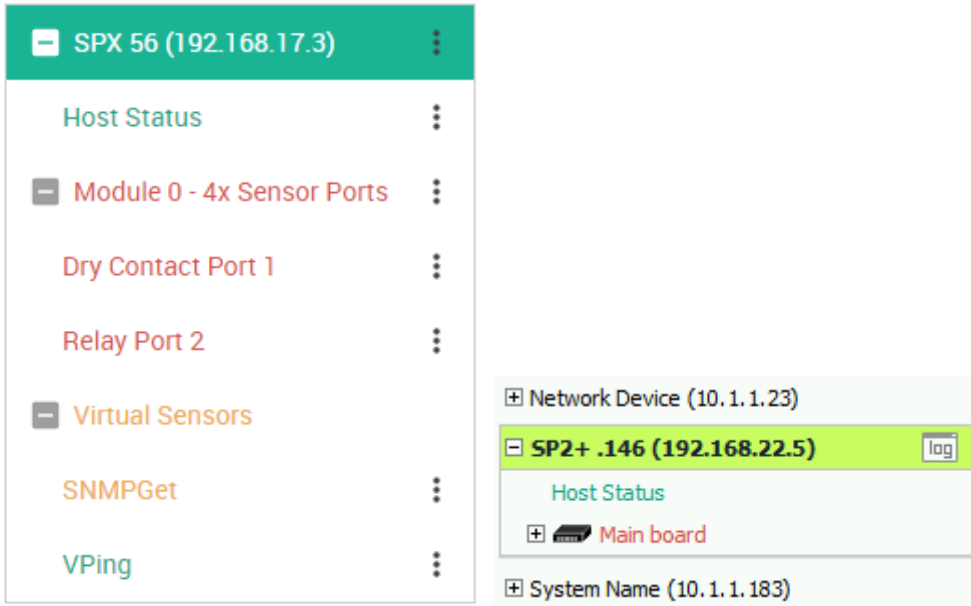

Important notes:

- A) If the SP+ was previously added to the APS using a LAN IP, it has to be removed (delete host). Connecting by VPN will use a different IP address for SP+ but the unit's MAC address is the same, and they'll be in conflict. This is not an issue if the unit has never been added to APS before.
- B) If the SP+ unit was previously monitored by APS, you should do a "reset to factory defaults" from the Maintenance menu to fully remove the APS integration from the unit (the existing IP configuration can be kept).
- C) The Virtual Sensor Ping cannot ping an IP address on the VPN network.

Important notes for VPN setup with modem connection:

- Port Forwarding to the APS is needed to be set up on your router (allow incoming VPN connection on your selected port)
- The Internal Modem on the unit has to be configured first with the correct APN settings

SMTP

The SMTP server configuration options are shown here, it's required to be set up for the Email actions.

Fill out all parameters; the address in the *Email From* parameter will be used by the Email actions by default, but you could change it if your mail server supports it (when it's not required to match the SMTP user for example).

SSL/TLS and STARTTLS are supported for the connection security.

You could also turn off any email sending from the unit by disabling the *Send Email* option.

Settings for Gmail

The screenshot shows the Gmail SMTP configuration interface. It includes the following fields and options:

- Send Email:** Radio buttons for Enable and Disable.
- Email From:** Text input field containing a masked email address ending in @gmail.com.
- SMTP Server:** Text input field containing smtp.gmail.com.
- SMTP Port:** Text input field containing 587.
- SMTP Authentication:** Radio buttons for Enable and Disable.
- Login Name:** Text input field containing a masked email address ending in @gmail.com.
- Password:** Password input field with masked characters.
- Confirm Password:** Password input field with masked characters.
- Connection Security:** Dropdown menu set to STARTTLS.

You can use Gmail account to send Email alerts with the settings shown on this screenshot on the left.

Important: before this can work, you'll need to set up an additional setting in your Google account.

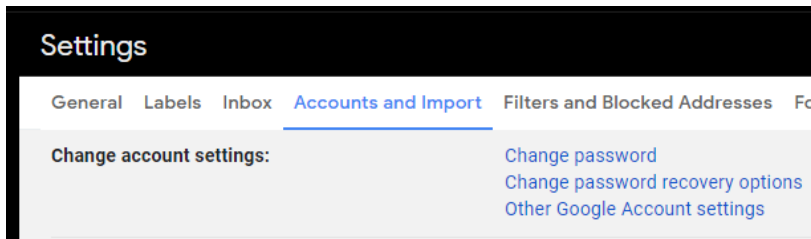

Open Gmail in a web browser and go to Settings / Accounts and Import / Other Google Account settings

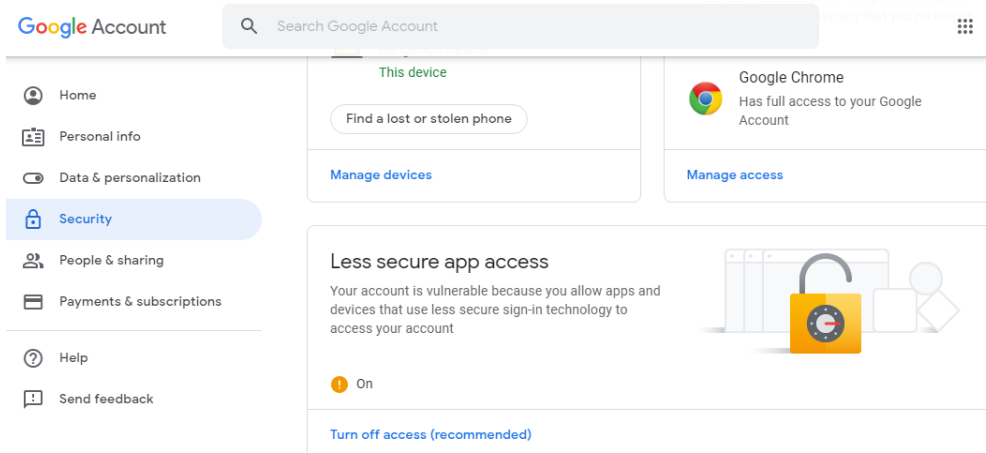

Then from the Account settings open Security tab / **Enable Less Secure Apps**

Settings for office365

Important Note: Sending office365 email alerts are only supported on the SP+ F7 & H7 units running the latest firmware on our website and are not supported on the older F4 type SP+ units.

First you need to ensure that the SMTP settings and the email action configuration are correct as follows (our account is used as an example):

SMTP

System / SMTP

Send Email

Email From

o365@akcp2.onmicrosoft.com

SMTP Server

smtp.office365.com

SMTP Port

587

Connection Security

STARTTLS

SMTP Authentication

Login Name

o365@akcp2.onmicrosoft.com

Password

Confirm Password

Email Action

Notifications / Actions / Email Action

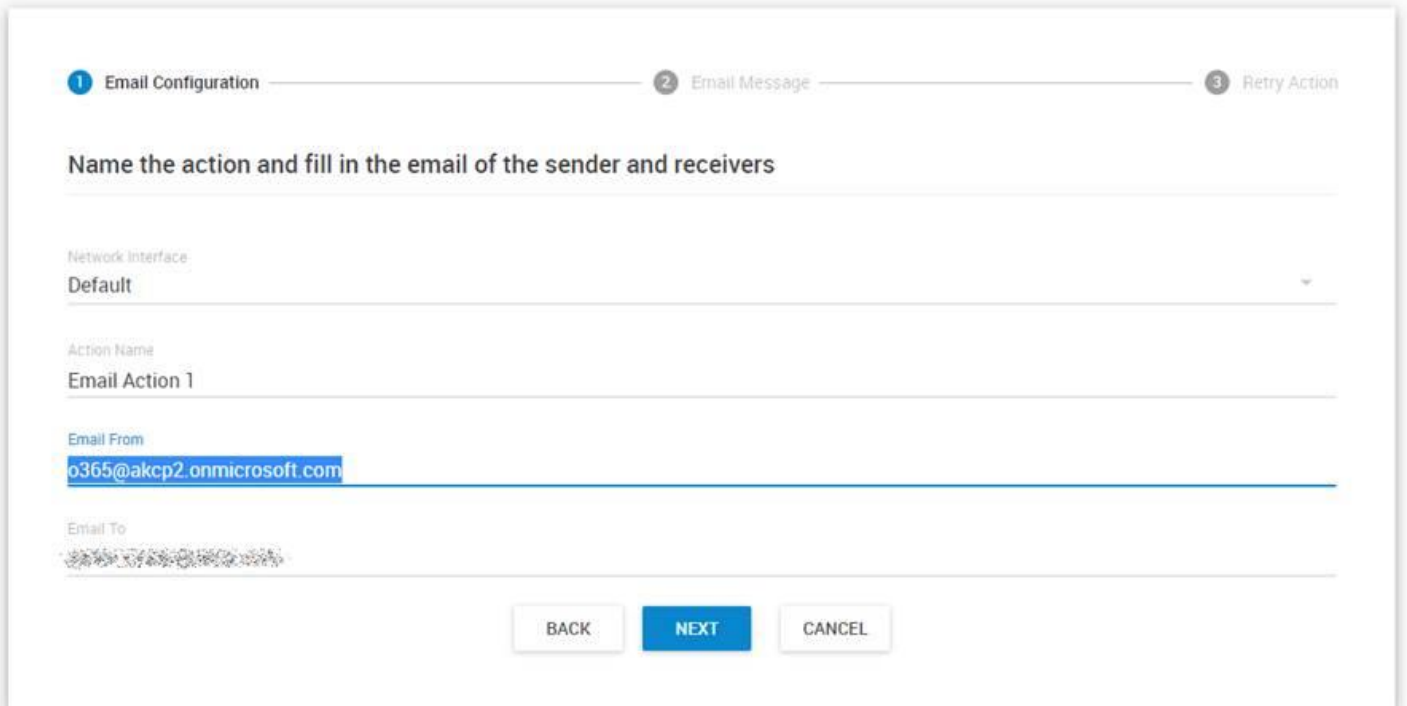

1 Email Configuration — 2 Email Message — 3 Retry Action

Name the action and fill in the email of the sender and receivers

Network Interface
Default

Action Name
Email Action 1

Email From
o365@akcp2.onmicrosoft.com

Email To
[Masked]

BACK NEXT CANCEL

Very important: the “Mail from” parameter must match the same as the SMTP login parameter in the settings.

The mail servers are strict about the "mail from" parameter for antispam methods, and it cannot be different than the email login setting.

Please also check our SP+ Knowledge Base using this link:

<https://www.akcp.com/knowledge-base/sensorprobe-plus-series-knowledge-base/>

And also, our SP+ Email Setup Quick Start guide using this link:

<http://www.akcp.in.th/downloads/Manuals/SP2+/SP+%20Email%20Alerts%20Quick%20Start%20Guide.pdf>

SNMP

System

AKCP SP2+

System / SNMP

SNMPv1/v2c

SNMPv1/v2c Enable Disable

SNMP Port

Read Community

Confirm Read Community

Write Community

Confirm Write Community

The SNMP service configuration options are shown here, it is required for SNMP operations.

SNMPv1 is enabled by default, with community password “**public**”.

This is provided for the easiest integration with third party SNMP tools.

For enhanced security, it is recommended that you change the default SNMP password.

Scroll down for SNMPv3 options.

SNMPv3

SNMPv3

ⓘ This feature has no license. To request a license click [here](#).

SNMPv3 Enable Disable

SNMPv3 Mode: Authentication Only

SNMPv3 engineID: AKCP
engineID parse: 80001F8804414B4350

SNMPv3 Username: admin

Access Privilege: Read Only

Authentication Protocol: SHA

SNMPv3 Pass Phrase: SNMPv3 Pass Phrase

Confirm SNMPv3 Pass Phrase: Confirm SNMPv3 Pass Phrase

Privacy Protocol: AES

Privacy Protocol Pass Phrase: Privacy Protocol Pass Phrase

Confirm Privacy Protocol Pass Phrase: Confirm Privacy Protocol Pass Phras

The SNMPv3 options can be found by scrolling down on the SNMP page.

This feature requires a separate license. You can read more details about the licensing below in this manual.

Below we'll give a quick description of each setting:

<u>Level</u>	<u>Authentication</u>	<u>Encryption</u>	<u>Description</u>
No Authentication	Username	No	Match Username (same as SNMP v1/v2c)
Authentication Only	MD5 or SHA	No	Auth Based on Algorithms (check password)
Auth&Privacy	MD5 or SHA	Yes - DES	Auth Algorithms and Encryption

Basically if you select **No Authentication** then the setup will be the same as with SNMP v1 and v2c versions: authentication is only checked by unencrypted username.

Authentication Only will provide password protection but no encryption.

Authentication&Privacy provides encrypted username and password protection.

Server Integration

The screenshot shows the 'Server Integration' configuration page in the AKCP SP2+ web interface. The page has a blue header with the AKCP logo and 'SP2+'. A sidebar on the left contains navigation links for System, General, Date/Time, Network, Modem, VPN, SMTP, and SNMP. The 'Server Integration' link is highlighted. The main content area displays the following settings:

- Server Integration:** Radio buttons for 'Enable' (selected) and 'Disable'.
- Server Address:** 10.1.1.111
- Server Integration Port:** 5000
- Send Keep Alive Every:** 1 Minutes
- Server Access Control Sync:** Radio buttons for 'Enable' (selected) and 'Disable'.

At the bottom of the settings are 'Save' and 'Cancel' buttons.

If the unit has been added to the AKCPro Server console, the server's IP address will be displayed here. User configurable options are the APS port and keep-alive period.

The image shows a close-up of the 'Send Keep Alive Every' dropdown menu. The menu is open, displaying a list of options. The '1 Minutes' option is currently selected and highlighted in blue. The other options are: 30 Seconds, 5 Minutes, 10 Minutes, 15 Minutes, 30 Minutes, 1 Hour, 2 Hours, 5 Hours, 12 Hours, and 24 Hours.

You can change the APS port when the server's port changes, and the keep-alive period (heartbeat sync to APS).

Alternatively you can re-initialize your unit from the APS console to re-establish communication.

You may disable the **Access Control Sync** on this device. This will disable importing the Access Control users and groups that are set up in APS. This feature is used by the Swing Handle Lock.

Services

The screenshot shows the 'Services' configuration page in the AKCP SP2+ web interface. The page is titled 'Services' and 'Web Interface'. It contains three main sections:

- Web Interface (HTTP)**: Enable Disable. HTTP Port: 80
- Secure Web Interface (HTTPS)**: Enable Disable. Use as Default. HTTPS Port: 443
- Upload Certificate File**: Choose file

At the bottom of the configuration area are 'Save' and 'Cancel' buttons.

You can close or change the ports used to access the unit’s web interface, disable HTTP and enable HTTPS only, which can also be set to be used as default.

On the SP+ family, the HTTPS supports TLS v1.1 and v1.2.
The HTTPS cypher suites are not customizable.

Using the “Upload Certificate File” option you can upload an SSL certificate that will be used by the unit’s Web UI for HTTPS connection (see below).

Important: the default, built-in self-signed SSL certificate is only provided for user convenience so that the HTTPS WebUI would work on the units out of the box. It WILL raise browser SSL security warnings and is not meant to be used in production environments where higher security is mandatory. To use SSL without warnings, you need to either add the units IP address to the exceptions, or replace the certificate using the method described below.

SSL Certificate

SSL certificates are generated for DNS host names and not IP addresses. You should set a host name for the SP+ unit in your local DNS server or DHCP server, and then generate the SSL certificate for that host name.

Example: spplus.mycompany.org

The unit's DNS host name is "spplus". Wildcard SSL certificates should also work, but this hasn't been tested.

If the name doesn't match with the one in the certificate, the browser will still show a security warning.

You can purchase a certificate from a trusted, verified Certificate Authority such as GoDaddy or use your company's own CA if you have one.

Please note that only non-password protected certificate files are supported.

When you select the file for uploading, you'll get a warning if the file is not in .PEM format:

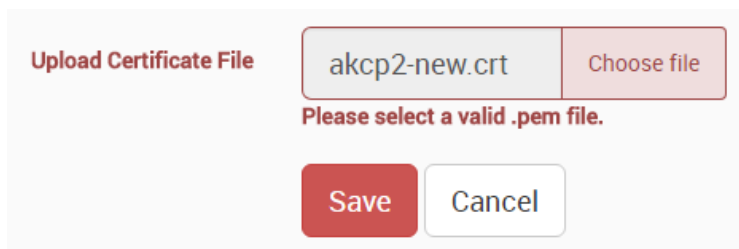

The screenshot shows a dialog box with the following elements:

- Upload Certificate File**: A label on the left side of the dialog.
- akcp2-new.crt**: The filename entered in the text input field.
- Choose file**: A button to the right of the text input field.
- Please select a valid .pem file.**: A red error message displayed below the input field.
- Save**: A red button at the bottom left.
- Cancel**: A white button with a grey border at the bottom right.

If you don't upload a certificate but enable HTTPS, a built-in certificate will be used. You'll get a browser warning upon opening the Web UI about an incorrect certificate. This is normal and you should add it as an exception or proceed, depending on your browser:

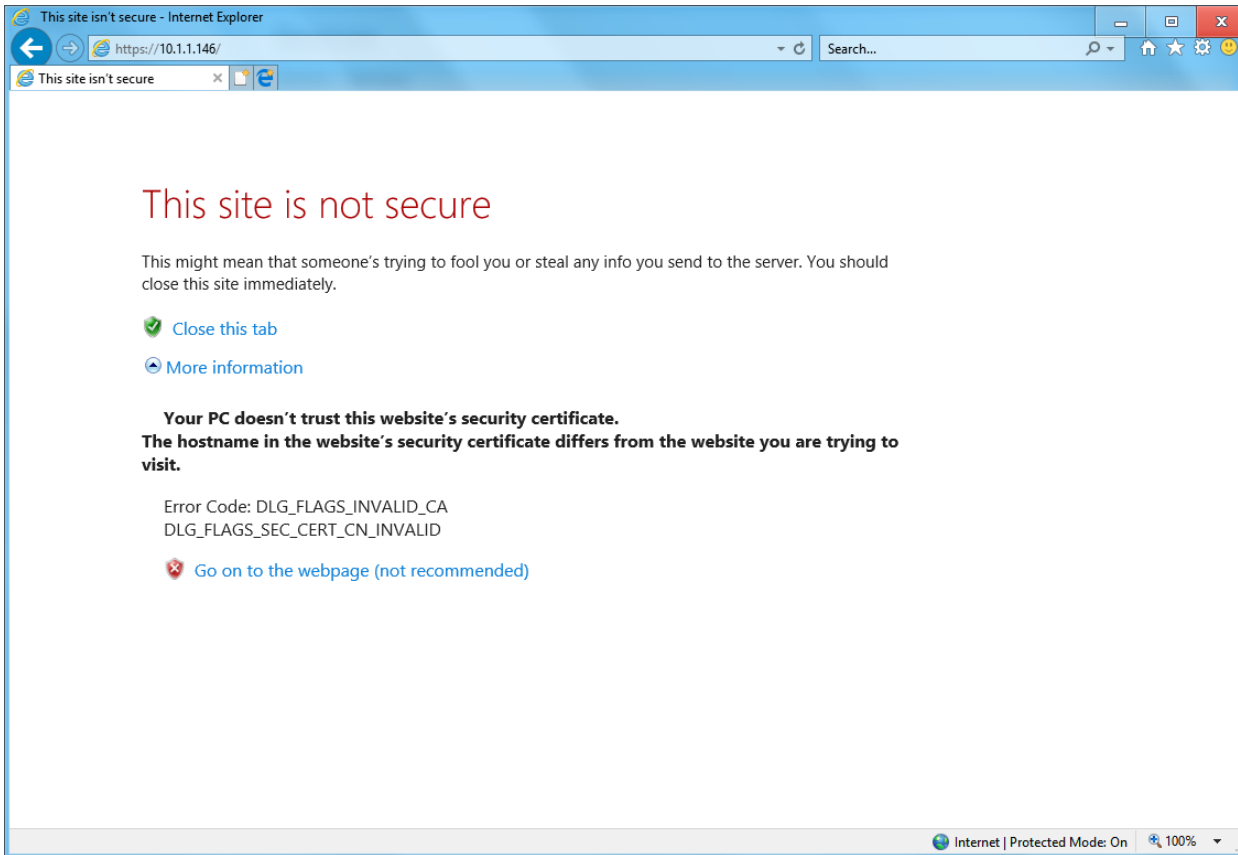

Important: the default, built-in self-signed SSL certificate is only provided for user convenience so that the HTTPS WebUI would work on the units out of the box. It WILL raise browser SSL security warnings and is not meant to be used in production environments where higher security is mandatory. To use SSL without warnings, you need to either add the units IP address to the exceptions, or replace the certificate.

Modbus

MODBUS RTU is a non-proprietary serial communications protocol that is widely used in the process control industry actuation. The sensorProbe+ can represent both “master” and “slave” devices and supports both Modbus RTU (RS-485) and Modbus TCP protocols.

SP2+ Expansion and SPX+ currently only supports Modbus with RJ45 connector (RTU and TCP) on its Expansion port. For just Modbus, only the pin 1 and 2 are used, being respectively, Modbus A/+ and Modbus B/-. You cannot use other sensor ports for Modbus other than the Expansion port.

Important: When you use Modbus, you can't connect expansion boards to the unit!

SP2+ Standard can only use the Modbus Virtual Sensors.

Note: Modbus queries are slow (up to 3 seconds). This is per Modbus protocol definition, it's not an AKCP limitation. The more sensors you have, the bigger the polling interval must be.

The screenshot displays the AKCP SP2+ web interface for configuring Modbus. The left sidebar contains a menu with options: System, General, Date / Time, Network, Modem, VPN, SMTP, SNMP, Server Integration, Services, **Modbus**, Password Checking, Maintenance, Heartbeat Messages, License Management, and About. The main content area is titled 'Modbus TCP' and includes the following settings:

- Modbus TCP Slave:** Radio buttons for Enable and Disable (Disable is selected).
- Modbus TCP Unit ID:** Text input field containing '1'.
- Modbus TCP Data Ordering:** Dropdown menu set to 'High Byte First, High Word First'.
- Modbus TCP Port:** Text input field containing '502'.
- Modbus TCP Timeout:** Text input field containing '60000' and a time selector set to '16h 40m 0s'.

Below the TCP settings is the 'Modbus RS485' section:

- Modbus RS485:** Radio buttons for Enable and Disable (Disable is selected).
- Modbus RS485 Mode:** Dropdown menu set to 'Modbus RS485 Master'.

At the bottom of the configuration area are 'Save' and 'Cancel' buttons. Below this is the 'Modbus Sensors Addressing' section, which contains a table of configured sensors:

Modbus INPUT Register Address	Unit	Sensor Name	
00000 (0x0000)	Main board	Relay Port 3	
00002 (0x0002)	Main board	Temperature Port 1	

An 'Add' button is located at the bottom right of the table.

Configuring the Modbus options and more information about this feature is explained in the separate **SP+ Modbus manual**.

Password Checking and Security

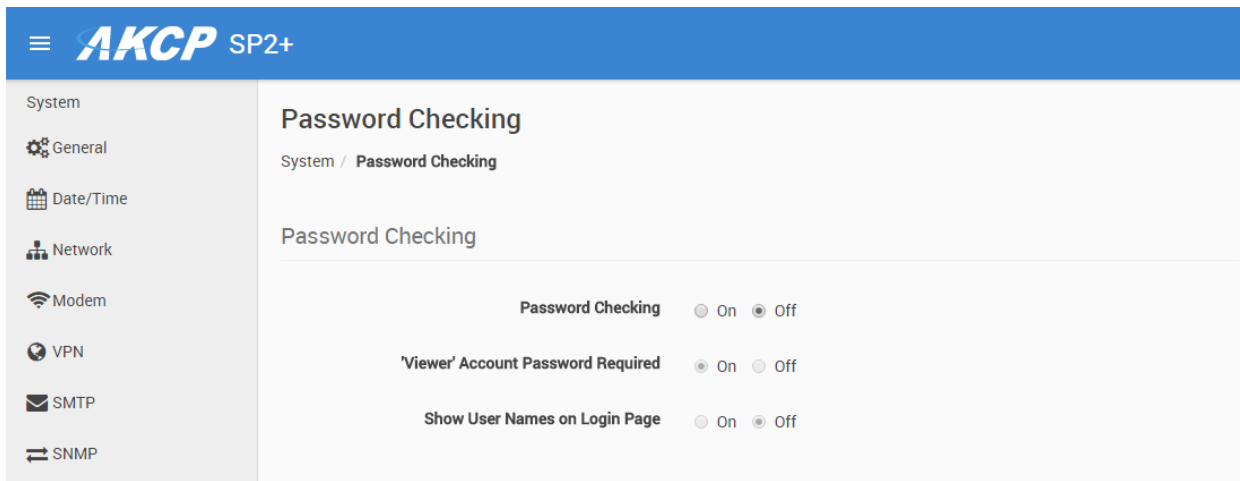

You can turn on the password checking for the Web UI to ensure only authenticated users have access to the unit. You can also specify to show all user names on the login page, or keep them confidential.

After you enable the password checking, you'll need to re-login.

If you don't remember the Admin password, you can hold the unit's reset button for 7-12 seconds to be able to log in to the Web UI without a password.

Note 1: The passwords can only be set from the unit's Web UI; this option is not available from APS.

Note 2: The default password is "public" for all access levels.

Web UI user access levels and permissions

Admin - full access to all settings, system and notification configurations

Viewer - read-only guest access for every page

User - full access to most settings except for those which are the system-related such as network

In detail, the User access level provides these permissions in addition to the Viewer level:

- Allow modifying board/sensor settings
- Allow add/modify/remove notifications
- Allow add/modify/remove heartbeats
- Allow open/close the door on the Handle Lock
- Allow send configuration to Support
- Allow change Graph settings
- Allow change the Web UI language

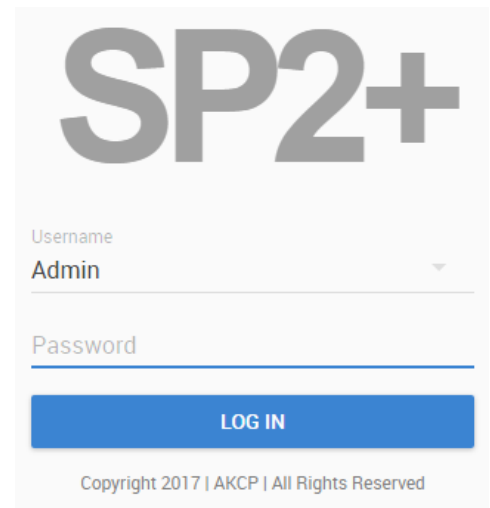

Password Security options

System

AKCP SP2+

System

- General
- Date/Time
- Network
- Modem
- VPN
- SMTP
- SNMP
- Server Integration
- Services
- Modbus
- Password Checking**
- Maintenance
- Heartbeat Messages
- License Management

Password Security

Admin Password	<input type="text" value="Admin Password"/>
Confirm Admin Password	<input type="text" value="Confirm Admin Password"/>
Password Expiration	90 Days ▾
Lock-down period after invalid login attempts	5 Minutes ▾
User Password	<input type="text" value="User Password"/>
Confirm User Password	<input type="text" value="Confirm User Password"/>
Password Expiration	90 Days ▾
Lock-down period after invalid login attempts	5 Minutes ▾

[Unlock User Account](#)

All user account types (Admin, User, Viewer) have adjustable password expiration and lockdown periods.

The password can be up to 15 characters (a-z, A-Z, 0-9 and special characters).

The IP address of the remote user's computer will be logged in the syslog so you can trace back each login session to its origin.

F7 units also support Radius password checking (licensed separately), we have a separate manual about this feature.

Lockdown

User Password	<input type="text" value="User Password"/>
Confirm User Password	<input type="text" value="Confirm User Password"/>
Password Expiration	90 Days ▾
Lock-down period after invalid login attempts	5 Minutes ▾
Viewer Password	<div style="border: 1px solid #ccc; padding: 5px;"> None 1 Minute 3 Minutes 5 Minutes 10 Minutes 15 Minutes 30 Minutes 60 Minutes 90 Minutes <b style="background-color: #007bff; color: white;">Indefinitely </div>
Confirm Viewer Password	
Password Expiration	90 Days ▾

⚠ Error!
The username or password is incorrect.

⚠ Error!
The username or password is incorrect.

⚠ Error!
Your account has been locked because you have reached the maximum number of invalid login attempts. Please try again later.

⚠ Error!
Your account has been locked because you have reached the maximum number of invalid login attempts. Please try again later.

The accounts can be set to lock down the account after 3 invalid login attempts, to prevent brute-force hacking attempts. You can specify how long the account will automatically unlock itself.

Note that for the Admin user, you can't select "indefinitely" as this would prevent you from logging in to the Web UI if it has locked itself.

If an account has been locked, you can unlock it immediately by logging in with the Admin user, and by using the green unlock button:

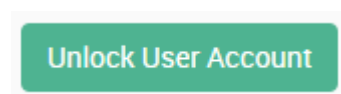

Username

LOG IN

Password Expiration

Admin Password	<input type="text" value="Admin Password"/>
Confirm Admin Password	<input type="text" value="Confirm Admin Password"/>
Password Expiration	<input type="text" value="90 Days"/>
Lock-down period after invalid login attempts	<input type="text" value="None"/>
User Password	<input type="text" value="User Password"/>

You can specify password expiration between every 15 and 90 days for all account types. You could also set “none” to disable expiration.

Confirmation

Your password has expired. Would you like to change it now?

YES NO

You’ll get a notification upon login when the password has expired, and will be asked to change it. It’s advised to change it when asked, but you can still proceed without changing.

Maintenance

On this page the following options are available:

Clear Event Logs: clears all logged events.

Restore Original Settings: removes all customized settings and returns the unit to factory defaults - you can also choose to keep the network configuration intact.

Backup/Restore All Settings: the unit's configuration can be backed up to a file and restored quickly and easily. You can choose to keep the present network settings, if the backup file is from another unit. The backup file contains all settings and notifications for the unit.

Send Configuration To Support: when asked by Support, this sends the unit's backup file to us. This also contains the device's internal logs which are useful for troubleshooting.

System Firmware Upgrade: allows you to upgrade to the latest firmware of the unit - alternatively you could upgrade from APS. We'll show you the process of the Web UI firmware upgrade below in another section.

System Reboot: this will initiate a software reboot of the unit, useful when you only have remote access. You'll need to specify the Admin user's password again.

Heartbeat Messages

System / Heartbeat Messages

Search Heartbeat Tasks

Name ^	Task ^	Next Run Time ^	Last Run Time ^	Result ^	Success ^
--------	--------	-----------------	-----------------	----------	-----------

This feature allows you to set up periodical “keep alive” notifications task by email, SMS or SNMP Trap to indicate the unit is still working properly.

We'll show you how to set up these in another manual with the other notifications and actions.

Features that needs separate licensing:

- **5 Dry Contact option:** Allows you to connect 5 dry contacts (input only) per sensor ports. See below for more information.
- **Access Control User licenses over 100:** The first 100 user licenses are free (1 is always used for the Admin user), and you can get more licensed users in blocks of 100; the limit is 1000.
- **SNMPv3 feature:** Allows you to use and configure secure, authenticated SNMP trap messages.
- **Virtual Sensors:** Allows you to use and configure virtual sensors. The first 5 sensors are free, you can get more license in blocks of 5.
- **VPN feature:** Currently the APS VPN integration is supported, to use a secure VPN channel between the unit and APS. Please note that when using this option, the number of maximum sensors that can be used by the unit will be reduced to 34 on the older F4 units.
- **3rd Party Modbus Device:** Allows you to easily integrate your Modbus devices with the SP+ units using configuration template files. This is only available on units with expansion ports.
- **F7 units:** IPv6 and Radius features (see separate manuals about these).

About Dry Contact Inputs

The dry contact inputs can be configured as **inputs only up to 5 Volts**.

1

Auto Sense

5 Input Dry Contact

2

Auto Sense

N/C

3

Auto Sense

N/C

4

Auto Sense

N/C

5 Input Dry Contact

- Dry Contact Port 1.1
- Dry Contact Port 1.2
- Dry Contact Port 1.3
- Dry Contact Port 1.4
- Dry Contact Port 1.5

5 Input Dry Contact

Advanced | Continuous Time

Sensor Name:

Sensor Status: Normal

Sensor Currently: Online

Description of Status When Normal:

Description of Status When Critical:

Description of Status When Sensor Error:

Offline All Sensors In Error On This Port

Save

Practical applications:
 The dry contact inputs can be used to monitor many types of equipment, for example, you can run the connection from warning lights on alarm panels to the dry contact inputs, so that when the warning light on the alarm panel is activated, the dry contact is triggered, thus allowing you to send notifications via emails or SNMP traps.

About

The screenshot shows the 'About' page of the AKCP SP2+ web interface. The page has a blue header with the AKCP logo and 'SP2+' text. A left sidebar contains a menu with various system settings. The main content area is titled 'About' and shows the following information:

System Description	SP2+ 1.0.4307 May 16 2018 13:56:05
Manufacturing Date	Friday, 24 November 2017
Manufacturer Name	AKCP
Product Name	SP2+ with Expansion
Product Code	-
Ethernet MAC ID	00:0B:DC:10:01:85
Modem IMEI Number	863789020696799
Modem Version	SIM5360E_V3.5

This page shows information about the **Manufacturing Date**, **Ethernet MAC ID**, **System Description** and **unit type (F4/F7)** which are important when you request support. If equipped, the internal modem's details will be also listed here.

You could make a similar screenshot when you need help with your unit, as this information can help us diagnose the problem.

Sensors page

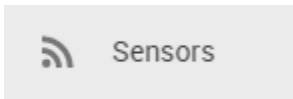

On this page you can view all sensors connected to the unit per port.

Non-connected sensors will be also displayed, until you re-attach or manually remove them from the configuration.

You could also rename the unit's Main board by clicking on the pencil icon: 

Please note the **maximum supported cable length to use with Thermal Map Sensors:**

Maximum extension cable length from the SP2+ sensor port to the TMS using CAT5 = 28 Feet

Maximum extension cable length from the SP2+ sensor port to the TMS using CAT5e & CAT6 = 60 Feet

Important note: If you're using analog pins on the sensor ports (with manually on-lined DCV sensors, and pin 7 of the RJ45 connector) make sure that the **voltage doesn't exceed 3 Volts**. Otherwise you can damage the unit!

General options for all sensors

You can change the following general options for all sensors:

Disable Auto Sense

Auto Sense

Click on the **Auto Sense** button to turn off the automatic sensor detection for a port.

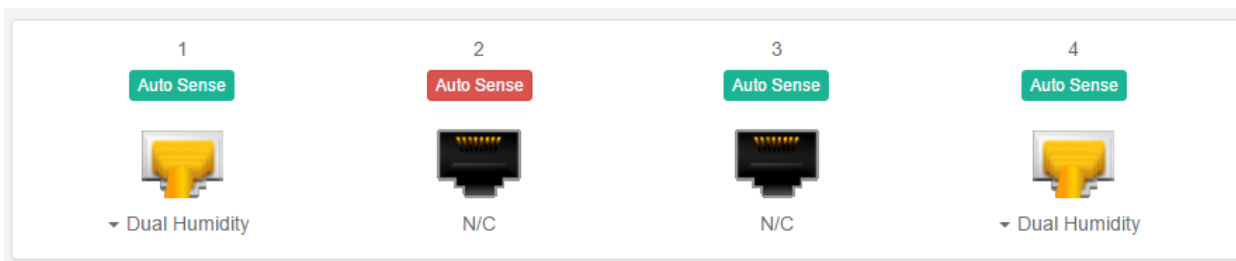

This feature is useful if you want to simulate a sensor (this works for Relay type sensors) or to prevent a sensor from going offline state. Note however that the sensor will be in “sensor error” state if the unit can’t get any reading from the sensor.

Choose Sensor Type

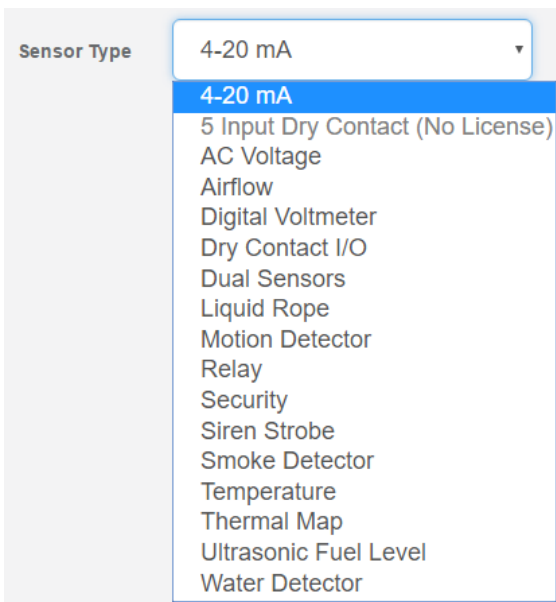

You can pre-configure a specific sensor type if needed, for example if you put the sensor offline before.

Offline a sensor

Sensor Currently

You can manually offline any sensor by clicking on the green **Online** button on the sensor's configuration page.

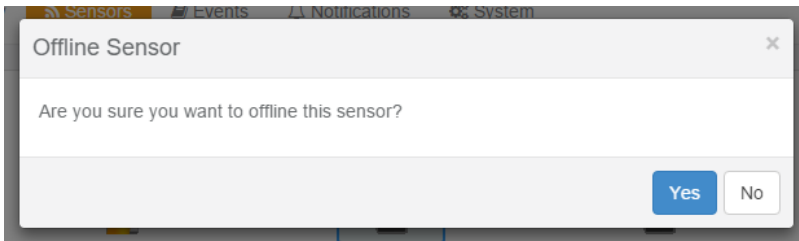

You'll be asked for confirmation in a popup window.

Note: if you change a sensor to “offline” it will no longer be displayed on the web interface. In order to reactivate it, you have to toggle it back to “online”.

Smart Sensor Recovery

This feature will be used **only** for the new **Smart Sensor** type. The firmware can be updated on these sensors automatically, and if the upgrade has failed for some reason and the sensor becomes unresponsive, with this option you can recover them to the default firmware. It's not used by other sensor types.

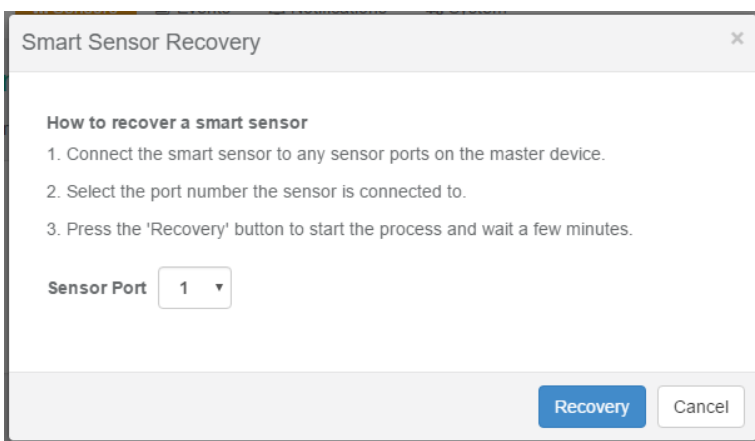

Note:

If there's a difference between the version stored in the unit's firmware and the sensor's firmware, it will upgrade/downgrade the sensor's firmware upon powering up/reboot of the unit, or on sensor reconnection.

If you need to downgrade the smart sensor firmware, you can only do so together with the unit's firmware.

Change Continuous Time

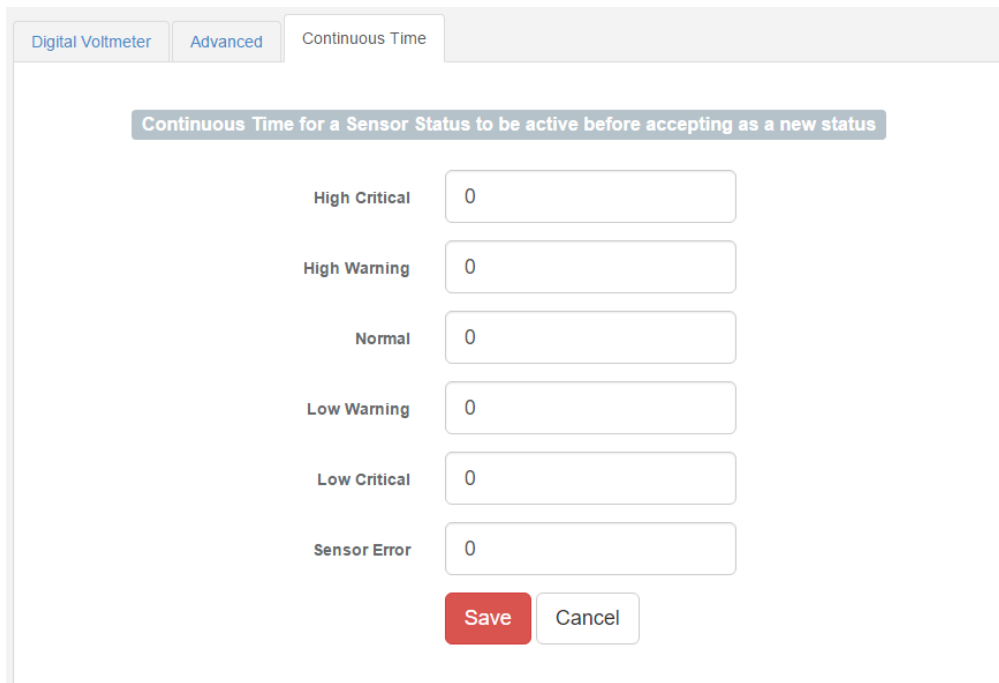

Digital Voltmeter Advanced Continuous Time

Continuous Time for a Sensor Status to be active before accepting as a new status

High Critical	0
High Warning	0
Normal	0
Low Warning	0
Low Critical	0
Sensor Error	0

Save Cancel

The following advanced functions are for setting the time frame in which the system should delay a notification being triggered when a sensor gives a reading that exceeds the thresholds (high warning, normal, etc).

Continuous Time to Report High Critical: This helps to eliminate unnecessary messages during minor fluctuations. You can set the amount of time to delay a notification of a status change from high warning to high critical. Enter the time in seconds and press the “Save” button. The amount of time that can be entered is between 0 and 65535 seconds which equals approximately 18 hours.

Continuous Time to Report High Warning: As above but delays notification for “High Warning”.

Continuous Time to Report for Normal: As above but delays notification for return to “Normal” state.

Continuous Time to Report for Low Warning: As above, but delays notification for “Low Warning” state.

Continuous Time to Report for Low Critical: As above but delays notification for “Low Critical” state.

Continuous Time to Report for Sensor Error: As above, but delays notification being sent for sensor going into an error state.

Example: An airflow sensor or humidity sensor may have temporary drops in readings which are normal operating characteristics; a logical time limit is set to show abnormal conditions.

Virtual Sensors

Virtual Sensors

Sensors / **Virtual Sensors**

1	2	3	4	5	6	7	8
N/C	N/C	N/C	N/C	N/C	N/C	N/C	N/C
9	10	11	12	13	14	15	16
N/C	N/C	N/C	N/C	N/C	N/C	N/C	N/C
17	18	19	20	21	22	23	24
N/C	N/C	N/C	N/C	N/C	N/C	N/C	N/C
25	26	27	28	29	30	31	32
N/C	N/C	N/C	N/C	N/C	N/C	N/C	N/C
33	34	35	36	37	38	39	40
N/C	N/C	N/C	N/C	N/C	N/C	N/C	N/C

On this page you can configure the Virtual Sensors. The first 5 sensors are free; if you need to use more you can purchase additional licenses (see the Licensing section in this manual).

Sensor Type Boolean

Sensor Name

- Boolean
- SNMP Get
- Virtual Ping
- Logic
- SNMP Trap Receiver
- Modbus

Virtual Sensors can be a very powerful tool in your monitoring system. On the SP2+ you can have up to 32 of these virtual sensors and they allow for a multitude of applications.

SNMP Get, sensor logic evaluation and ping commands among others are all possible from the virtual sensors. An example use of this could be to use the SP2+ as a probe manager. If you had a SP2+ and multiple sensorProbe devices they could all be monitored, mapped and alerted via the SP2+. You can perform SNMP Get commands on a server to monitor memory or CPU load, or you can ping network enabled devices and be alerted if they go offline.

Please note:

The Virtual Sensor Ping cannot ping an IP address on the VPN network.

We'll explain more about the Virtual Sensors and how to configure them in the **Notifications manual**.

Example sensor configuration

Below we'll show the configuration of 2 sensor types: the Temperature/Humidity and a Relay sensor. The configuration of these 2 types of sensors covers most settings that can be configured for other sensor types.

Temperature/Humidity Sensor

Click on the sensor port where the sensor is connected to open the sensor's configuration.

Note: another way of accessing this page is to click on the sensor from the Summary page.

1 Auto Sense
Dual Temperature

2 Auto Sense
Relay

3 Auto Sense
N/C

4 Auto Sense
Dual Humidity

Dual Temperature Advanced Continuous Time

Sensor Name Dual Temperature Port 1

Sensor Status Normal

Sensor Reading 26.0 °C

Sensor Currently Online

Low Critical Low Warning Normal High Warning High Critical

-55 → 10 → 20 → 30 → 40 → 75

Save Cancel

From this page you can carry out various operations. You can view the current status (normal, low critical, high critical etc), rename the sensor, put it offline and change the thresholds. In the screen shot above you can see the sensor is indicating a temperature of 26 degrees °C, and a status of Normal.

You can re-configure the thresholds for each sensor state. After changing a threshold value, click **“Save”**. In the next screen shot you can see that a threshold has been changed to 27 make a new “low warning” state, and along with it the sensor status has changed:

Note: the Humidity sensor has the same configuration options as the Temperature sensor.

You might see a **Temperature Search** option for the connected Temperature sensors:

What this button does is to search for new temperature sensors in a chain, if you've connected more than 1 sensor in a Daisy-Chain Temperature (DCT) sensor chain. It is **not** available for Thermal Map Sensors (TMS).

Advanced sensor configuration for Temperature/Humidity sensors

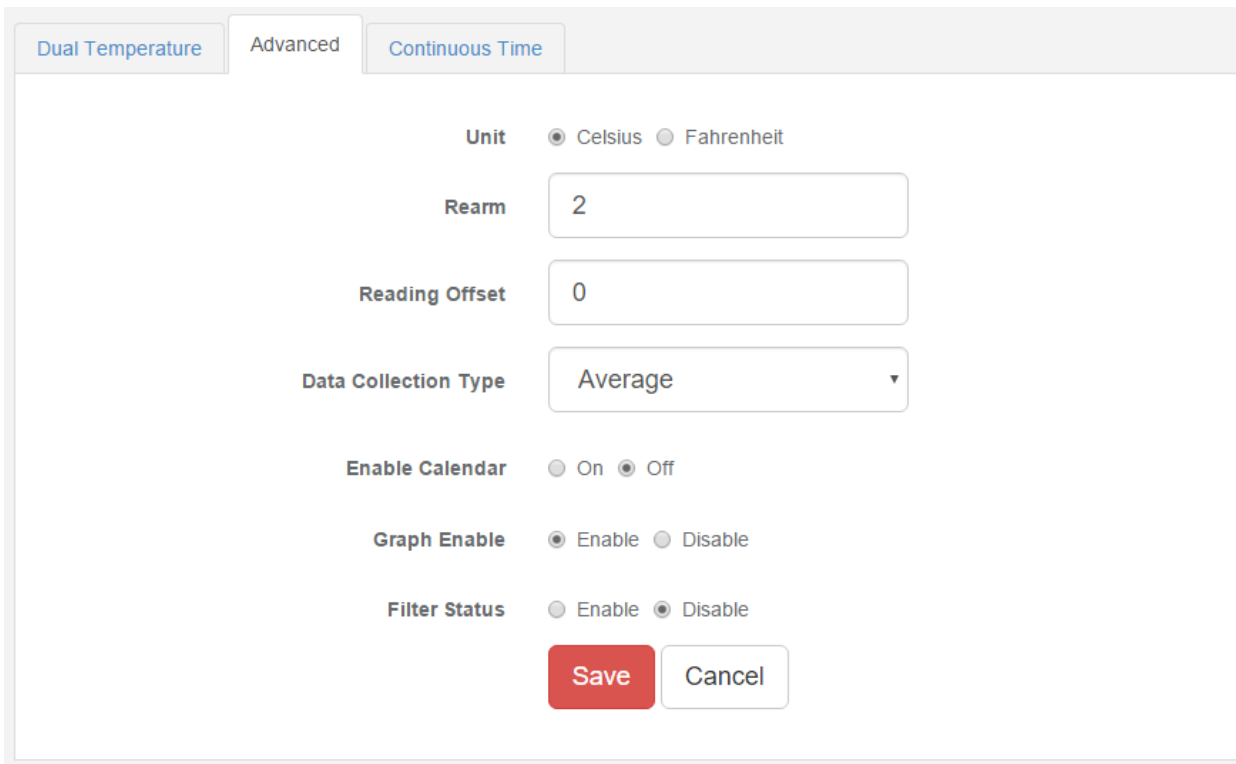

The screenshot shows a configuration window with three tabs: 'Dual Temperature', 'Advanced', and 'Continuous Time'. The 'Advanced' tab is selected. The settings are as follows:

- Unit:** Radio buttons for Celsius (selected) and Fahrenheit.
- Rearm:** Text input field containing the value '2'.
- Reading Offset:** Text input field containing the value '0'.
- Data Collection Type:** Dropdown menu with 'Average' selected.
- Enable Calendar:** Radio buttons for On and Off (Off is selected).
- Graph Enable:** Radio buttons for Enable (selected) and Disable.
- Filter Status:** Radio buttons for Enable and Disable (Disable is selected).

At the bottom of the form are two buttons: a red 'Save' button and a white 'Cancel' button.

Units: changes units from °C to °F or vice versa.

Rearm: The Rearm parameter is useful for sensors whose values can vary such as the temperature and humidity sensors.

It is used to prevent the sensor from rapidly changing between two states. For example if the **Warning High** threshold for the temperature sensor is set to 80 degrees and the sensor were to vary between 79 and 80 you could be faced with a very large number of emails, traps, and events logged. The Rearm parameter prevents this by forcing the temperature to drop by the Rearm value before changing the state back to normal. In this example, if Rearm is set to 2 then the sensor would have to drop from 80 down to 77 before the status would change from **Warning High** back to normal.

Reading Offset: The Reading Offset feature is a calibration tool. If you wish to calibrate the temperature sensor, for example, you could enter an offset value of 5. This would mean if the sensor reads 20 degrees then it would record as 25 degrees. This figure can also be a minus figure (e.g. -5 would show 15 degrees instead of 20).

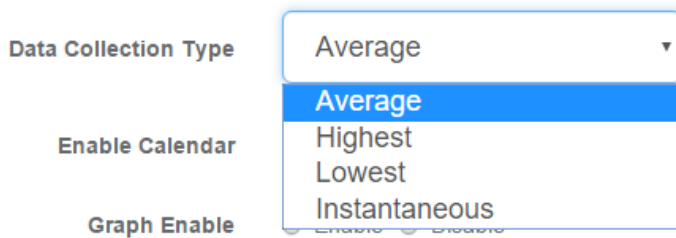

Data Collection Type: This refers to the data collection from the sensor and how the data is then displayed on the graphs.

There are four options for the collection of data: Average, Highest, Lowest and Instantaneous. The default setting is “Average”.

When the data collection type is set to “Average” the averaged value between 2 graph intervals is stored and output graphs for the daily, monthly, and yearly all have the same size on the screen. For the daily graph, each data point on the graph is one data point collected from the sensor. But for the monthly and yearly graph, in order to display more data into the same size as the daily graph, some consolidation on the data is needed. One data point on the monthly and yearly graph is an average of the sensor data in a range.

The maximum and minimum values showing on the monthly and yearly graphs are the value of this consolidated data and not the raw data over that period of that time.

When the Data Collection Type is set to the Highest setting then you will get the graphing output displaying the sensors highest average readings during sampling. This is the same for the Lowest setting (lowest average).

With the Instantaneous setting you can store the actual value of the sensor at the sampling interval without averaging.

Graph Enable: In order to save the data from the sensors on the unit you will need to enable the Graphing feature on the unit. You need to change the Enable Graph to the On position and click on the Save button to enable the graphing. Note that you could also enable the graphing from the Summary page.

Filter Status: The Sensor Filter Status is a feature that you can Enable or Disable and when enabled will check the sensor status. If the status of the sensor changes very rapidly, then it will report how many times the sensor status changed, instead of having multiple separate entries in the syslog. When enabled, this will report the changes and status of a sensor only once.

Relay Sensor

Click on the sensor port where the sensor is connected to open the sensor's configuration.

Note: another way of accessing this page is to click on the sensor from the Summary page.

You can directly see the Relay's current status below the sensor port.

The screenshot displays the configuration interface for a Relay Sensor. At the top, there are four sensor ports labeled 1, 2, 3, and 4. Port 1 is a Temperature sensor with a 'Sensor Error' status. Port 2 is 'N/C' (Not Connected). Port 3 is a Relay sensor with an 'Off' status, and it is the selected port. Port 4 is 'N/C'. Below the sensor ports, there are two tabs: 'Relay' and 'Advanced'. The 'Advanced' tab is active, showing the configuration for 'Relay Port 3'. The configuration fields are: 'Sensor Name' (Relay Port 3), 'Sensor Status' (Off), 'Sensor Currently' (Online), 'Boot Up State' (radio buttons for On and Off, with Off selected), 'Description of Status When Off' (Off, with a red color swatch), and 'Description of Status When On' (On, with a green color swatch). At the bottom, there are 'Save' and 'Cancel' buttons.

Boot Up State: You can change the state of the relay when the unit starts. The default is Off.

Description of Status When Relay Off/On: These fields are the custom description, which will be displayed in the Relay Status field when the relay state is off/on. The same text is listed as one of the relay actions used to turn off/on the relay. Examples for this field are Close/Open Door, Turn Pump Off/On, Turn Light Off/On, etc.

Color: You could assign a custom color for the Off/On status: click on the color and the color picker will be shown.

Advanced sensor configuration for Relay sensors

Sensor Control:

This button allows you to manually control the relay by controlling the cycle of the relay in an on-off-on or an off-on-off cycle. You can also set the “Toggle” (Cycle Time) here in seconds.

You don't need to change an option to be able to link the relay to an action.

The following actions can be chosen in an action: Turn on until sensor normal, turn off until sensor normal, cycle the relay, turn on until acknowledged, and turn off until acknowledged.

We'll explain more about these options in the Notifications manual.

Enable Calendar: Allows you to setup a *Calendar Profile* for what days and times you want or do not want the relay to be active.

Enable Calendar On Off

Calendar Profile

Calendar #1

Edit

Click on the **Edit** button next to a selected calendar to modify it.

Calendar Filter

Calendar Name: Calendar #1

All	AM											PM												
	12	1	2	3	4	5	6	7	8	9	10	11	12	1	2	3	4	5	6	7	8	9	10	11
Sunday	Blue	Blue	Blue	Blue	Blue	Blue	Blue	Blue	Blue	Blue	Blue	Blue	Blue	Blue	Blue	Blue	Blue	Blue	Blue	Blue	Blue	Blue	Blue	Blue
Monday	Blue	Blue	Blue	Blue	Blue	Blue	Blue	Blue	Blue	Blue	Blue	Blue	Blue	Blue	Blue	Blue	Blue	Blue	Blue	Blue	Blue	Blue	Blue	Blue
Tuesday	Blue	Blue	Blue	Blue	Blue	Blue	Blue	Blue	Blue	Blue	Blue	Blue	Blue	Blue	Blue	Blue	Blue	Blue	Blue	Blue	Blue	Blue	Blue	Blue
Wednesday	Blue	Blue	Blue	Blue	Blue	Blue	Blue	Blue	Blue	Blue	Blue	Blue	Blue	Blue	Blue	Blue	Blue	Blue	Blue	Blue	Blue	Blue	Blue	Blue
Thursday	Blue	Blue	Blue	Blue	Blue	Blue	Blue	Blue	Blue	Blue	Blue	Blue	Blue	Blue	Blue	Blue	Blue	Blue	Blue	Blue	Blue	Blue	Blue	Blue
Friday	Blue	Blue	Blue	Blue	Blue	Blue	Blue	Blue	Blue	Blue	Blue	Blue	Blue	Blue	Blue	Blue	Blue	Blue	Blue	Blue	Blue	Blue	Blue	Blue
Saturday	Blue	Blue	Blue	Blue	Blue	Blue	Blue	Blue	Blue	Blue	Blue	Blue	Blue	Blue	Blue	Blue	Blue	Blue	Blue	Blue	Blue	Blue	Blue	Blue

* To select a minute, right click at a cell. Working Hours / Inverse All

Close Save changes

Blue cells means that the notification is on, white cells means it's off.

All	AM											PM												
	12	1	2	3	4	5	6	7	8	9	10	11	12	1	2	3	4	5	6	7	8	9	10	11
Sunday																								
Monday																								
Tuesday																								
Wednesday																								
Thursday																								
Friday																								
Saturday																								

0	1	2	3	4	5	6	7	8	9
10	11	12	13	14	15	16	17	18	19
20	21	22	23	24	25	26	27	28	29
30	31	32	33	34	35	36	37	38	39
40	41	42	43	44	45	46	47	48	49
50	51	52	53	54	55	56	57	58	59

On
Off
Save

* To select a minute, right click at a cell.

Working Hours / Inverse All

You can quickly select the Working Hours only, and specify a custom schedule down to minutes by right clicking on a cell.

Pulse Counter sensor

1
Auto Sense
Pulse Counter
Low Critical

2
Auto Sense
Dual Humidity
Normal

3
Auto Sense
Dual Humidity
Normal

Pulse Counter | Advanced | Continuous Time | Status Text

Sensor Name: Pulse Counter Port 1

Sensor Status: Low Critical

Sensor Reading: 0 Unit

Last Reset: N/A Reset

Sensor Currently: Online

0 → 10 (Low Critical) → 20 (Low Warning) → 40 (Normal) → 50 (High Warning) → 100 (High Critical)

Save Cancel

The pulse counter is available on the SP+ platform, as of firmware version 1.0.4967. It provides:

- accumulated pulse count
- flow conversion of the pulse count

It can measure up to 1000 pulses / sec (1 Kilohertz).

Normally this sensor should be used with some external sensor which outputs pulses.

Sensors that could work: basically any switch type sensor, and any custom sensor that could generate a pulse signal. For example Wind speed sensor, Electricity meter etc.

For example, you can connect the output of a third-party water flow sensor in the market to our sensor port.

The specs of those sensors will indicate how many pulses equal to, for example 1 liter: 100 pulses = 1 Liter.

Then you can set the "Number of Pulses per Unit" to 100, and change the unit to L.

Then the sensor value will be changed according to the output of the water flow sensor which is connected to the sensor port.

How to use the pulse counter?

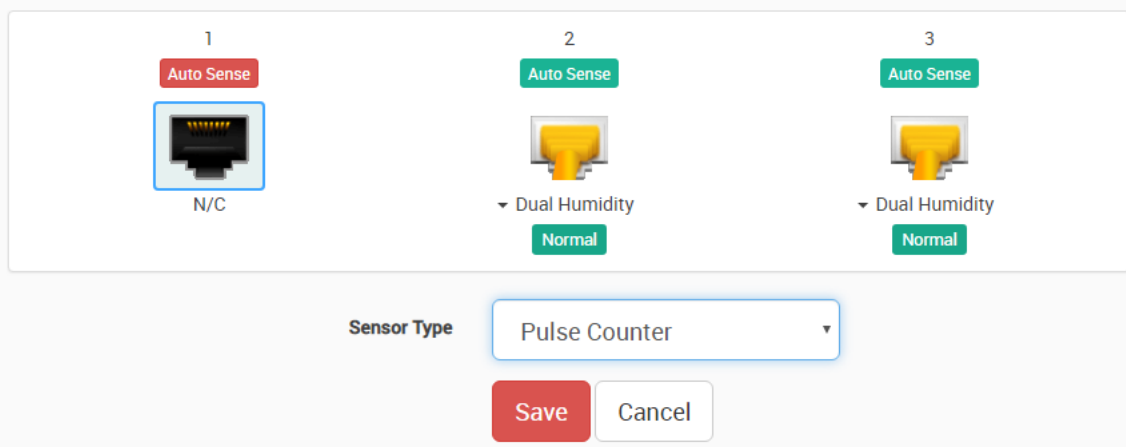

The sensor is designed to be used by disabling the Autosense and connecting an external sensor to the sensor port. This sensor will detect changes on the Data pin (Pin 2 of Sensor Port).

If there's changes:

- Flow Sensor value will show rate of the change in Unit / Second
- Pulse Counter will accumulate the pulses since the sensor is set to online

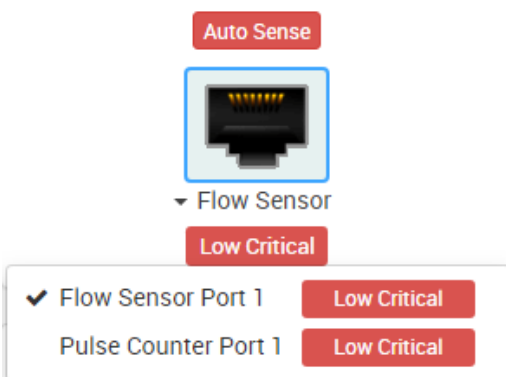

To set it up, disable Auto Sense on a sensor port and select the Pulse Counter sensor type from the list. This will give a dual sensor with Flow Sensor and Pulse Counter.

Connect the following pins from external sensor that you would like to measure to the SP+ sensor port:

Pulse + pin: SP+ sensor port **Pin 2 (Data)**

Pulse GND pin: SP+ sensor port **Pin 8 (GND)**

Flow Sensor Advanced Continuous Time Status Text

Edge Detection Mode

Unit

Number of Pulse per Unit

Time Period

Rearm

Calibration Factor

Min Value

Max Value

Enable Calendar On Off

Graph Enable Enable Disable

Filter Status Enable Disable

In the Flow Sensor there is "Number of Pulse per Unit" in the config. You can use this value to adjust the sensor reading to match the real-world value.

Dry contact will also work but only to count the pulses. If you want to test for the rate accuracy, you'd have to test with something that can generate a wave signal, like using an oscilloscope to generate wave form and plug it to the sensor port.

But the general idea of this sensor is that it will show the rate of received pulses and also count it.

Firmware upgrade through the Web UI

The firmware upgrade process is very simple and straight-forward.

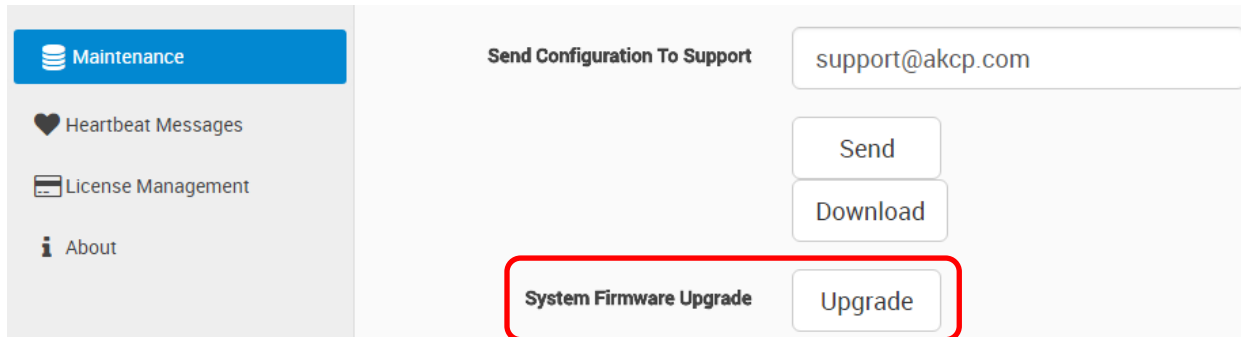

Open the **System/Maintenance** page and click on the **Upgrade** button at the System Firmware Upgrade section.

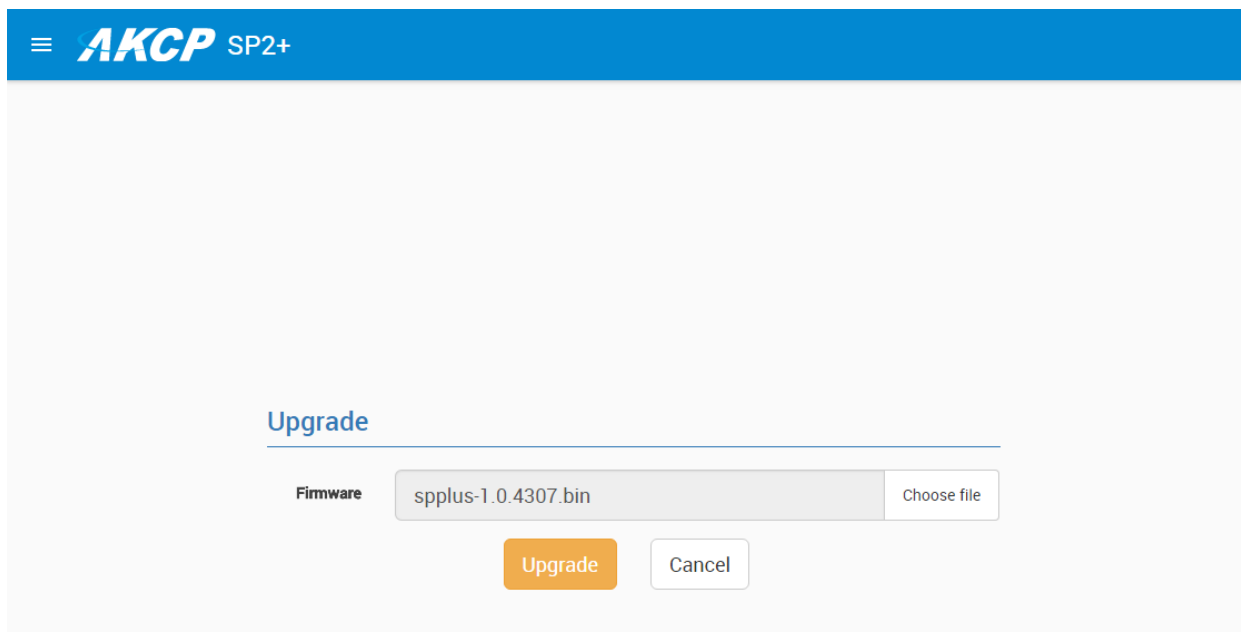

This will load the Upgrade page. Choose the firmware file from your PC and click on **Upgrade** to start the process.

Important: There are two separate .bin files included in a firmware update package. One for the F4 units and one for the F7 units. The .bin file for the F4 units is named spplus-1.0.xxxx.bin and the .bin file for the F7 units is named spplus_f7-1.0.xxxx.bin. If you try to upgrade your unit with the wrong .bin file, the firmware upgrade will fail, so please make sure you use the correct file for your unit type.

Uploading...



First the file will be uploaded to the unit...

Upgrading..

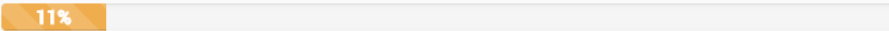

...then the upgrade process will run. The whole process can be done in a few minutes. The Power/Ethernet LED will be red during the upgrade.

Upgrade Completed



Refresh

The unit will reboot at the end of the upgrade. Click on the **Refresh** button to reload the Web UI.

Network ports used by SP+ units

Below we list the ports used by our SP+ units. Most of them are needed for external communications with APS, and to use network features.

Most ports are user configurable, these are the default ports.

Main ports:

- 5000 TCP for RPC with APS - note: not fully user configurable
- 161 TCP/UDP for SNMP
- 80 TCP for HTTP of Web UI

Other ports:

- 123 TCP for NTP (Network Time Protocol) - note: port is not user configurable
- 162 TCP/UDP for SNMP Trap
- 25 TCP for Email SMTP (if used)
- 1194 TCP/UDP for VPN (if used)
- 443 TCP for HTTPS of Web UI
- 502 TCP for Modbus TCP (if used)

FCC Statement

This device complies with part 15 of the FCC Rules. Operation is subject to the following two conditions:

- (1) This device may not cause harmful interference, and
- (2) this device must accept any interference received, including interference that may cause undesired operation.

NOTE: This equipment has been tested and found to comply with the limits for a Class B digital device, pursuant to part 15 of the FCC Rules. These limits are designed to provide reasonable protection against harmful interference in a residential installation.

This equipment generates, uses and can radiate radio frequency energy and, if not installed and used in accordance with the instructions, may cause harmful interference to radio communications. However, there is no guarantee that interference will not occur in a particular installation.

If this equipment does cause harmful interference to radio or television reception, which can be determined by turning the equipment off and on, the user is encouraged to try to correct the interference by one or more of the following measures:

- Reorient or relocate the receiving antenna.
- Increase the separation between the equipment and receiver.
- Connect the equipment into an outlet on a circuit different from that to which the receiver is connected.
- Consult the dealer or an experienced radio/TV technician for help.

Changes or modifications not expressly approved by the party responsible for compliance could void the user's authority to operate the equipment.



Please contact support@akcp.com if you have any further technical questions or problems.

Thanks for Choosing AKCP!